



DAKOTA
United Kingdom

 Drainage Products

Innovative Building Solutions

PRODUCTION AND DISTRIBUTION OF CONSTRUCTION PRODUCTS

Six divisions, more than four thousand innovative products dedicated to construction, fast deliveries, and more than 40 years of experience. High quality Italian designed and manufactured products for indoor and outdoor applications including drainage, flooring, landscaping and more.

Investing In Innovation Since 1980

It was only in 1980 when our first plastic injection machines were brought into operation for the moulding of construction products. Today, over forty years later, with more than 140 state-of-the-art moulding machines, the Dakota Group remains committed to developing and supplying innovative products for the construction industry. We consistently expand our product range and innovate on our production technologies - making our products increasingly advanced, higher performing, and occasionally unique.

Innovate to evolve. The only way forward.



Dakota Drainage Products

Channel drains, also known as trench drains, are arguably the most important component of modern drainage systems. Dakota Channel Drains and Catch Basins (Catchpits, Inspection Chambers) are an excellent choice for effective drainage solutions. Our wide range of innovative products offer numerous advantages that make them stand out in the market.

The main advantages of Dakota Channel Drains and Catch Basins are:

Two ranges of Channel Drains to choose from

The Taurus range is our professional quality, heavy duty, product line with extra thick walls and high strength offering solutions all the way from around the home right up to the heaviest applications for ports, airports, etc. The Pegasus product line is designed and constructed for domestic and lighter vehicle applications.

An extensive, industry leading, range of Catch Basins

The catch basins are made from polypropylene and are available in a range of sizes, from 200mm to 700mm (8" to 28") square, to suit any application. Siphoned traps are also available for many of the products to prevent drain odours.

Superior Drainage Performance

Dakota Channel Drains and Catch Basins are designed to efficiently collect and channel water, preventing pooling and potential water damage. Their advanced designs ensure effective water flow, reducing the risk of flooding or water accumulation. Channels are designed with lateral and bottom connection outlets, as well as with provision for T-joints and Cross-overs where possible, so no need to buy extra components.

Durable and Long-Lasting

These products are built to withstand heavy loads and harsh weather conditions, ensuring long-term durability. Made from high-quality HDPE or PP materials, Dakota Channel Drains and Catch Basins offer exceptional strength and resistance, making them a reliable choice for both residential and commercial applications. Most catch basins are offered with options for odour control as well as with a wide variety of lids or gratings to suit every requirement.

Easy Installation and Maintenance

Installing Dakota Channel Drains and Catchpits is a hassle-free process, thanks to their user-friendly slot together design. With simple installation instructions and minimal maintenance requirements, these products provide convenience and time-saving benefits.



Versatile Applications

Dakota Channel Drains and Catchpits are suitable for various applications, including driveways, patios, poolside, gardens, parking, roadway and commercial areas. Their versatility allows for seamless integration into different landscapes, providing effective drainage solutions wherever needed.

Aesthetically Pleasing

In addition to their functional benefits, Dakota Channel Drains and Catchpits are aesthetically pleasing. They feature a range of grate types, materials and designs that complement any outdoor space, enhancing visual appeal while efficiently managing water drainage.

Overall, Dakota Channel Drains and Catch Basins offer superior design, superior drainage performance, durability, easy installation and maintenance, versatility, and aesthetic appeal. The products are **made to meet or exceed the DIN19580 / EN 1433 standards** - the only recognized international standard written specifically for Channel / Trench Drains. These qualities make them an excellent choice for anyone seeking reliable and efficient drainage solutions.

Please note: All imperial measurements shown in this brochure are to the nearest common fraction. For exact dimensions please refer to metric measurements.

Taurus Line *Heavy Duty Professional Range*

all Classes up to F900 (90 metric tonne / 99 US tons)

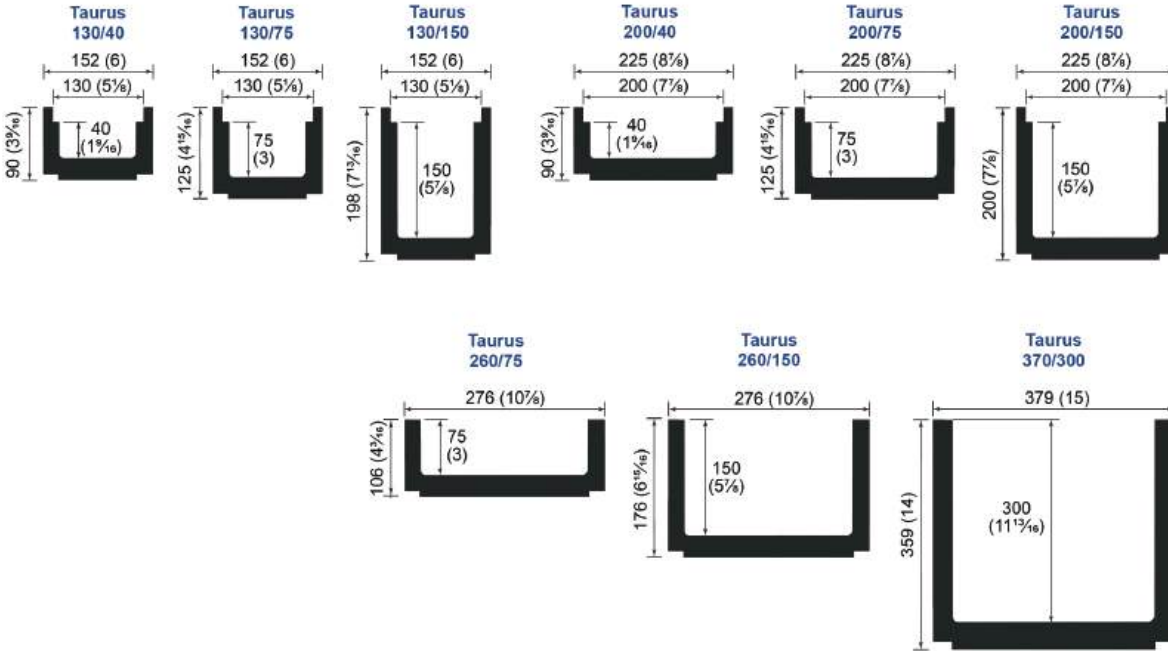

Pegasus Line *Domestic and Light Traffic*

Classes A15 up to C250 - up to (25 metric tonne / 27½ US tons)

S

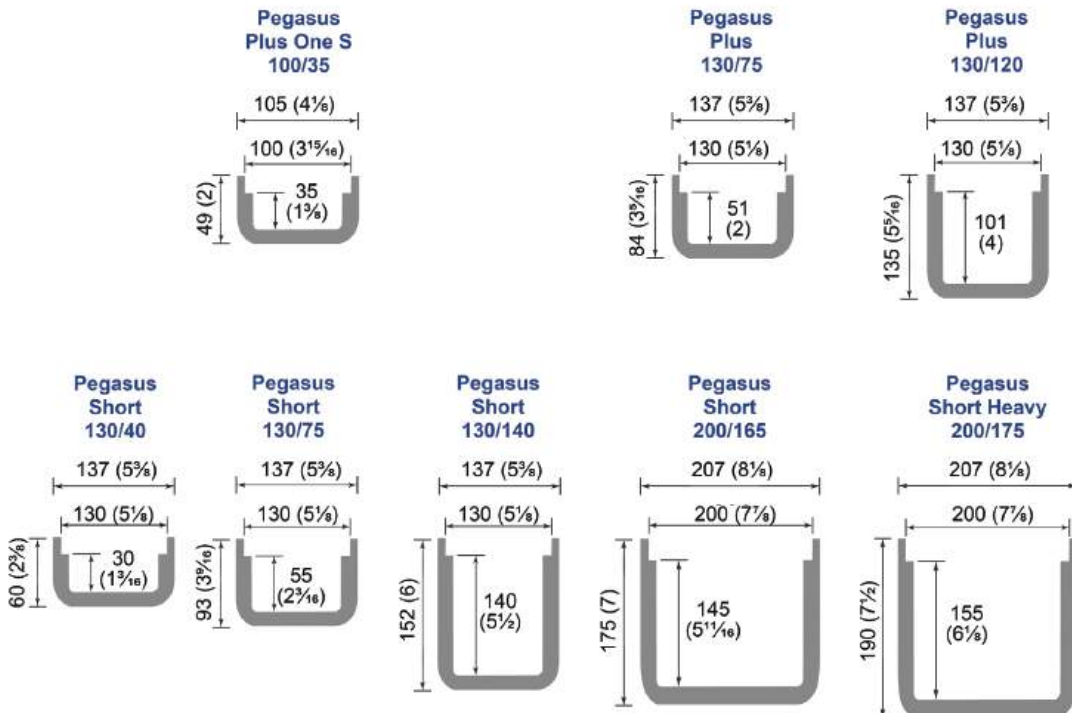

Load Classes

ACCORDING TO THE BS EN 1433 STANDARD

CLASS A

15 kN / 3,372 lbs. load test = 1.5 metric tonnes / 1.65 US tons
Group 1: Areas that can be used only by pedestrians and cyclists.

CLASS B

125 kN / 28,100 lbs. load test = 12.5 metric tonnes / 13.7 US tons
Group 2: Pavements, pedestrian areas and comparable areas, parking for private cars or multilevel car parks.

CLASS C

250 kN / 56,200 lbs. load test = 25 metric tonnes / 27.5 US tons
Group 3: Road curbs and areas not directly exposed to vehicle traffic or similar, commercial parking lots and general commercial areas.

CLASS D

400 kN / 89,920 lbs. load test = metric 40 tonnes / 44 US tons
Group 4: Roads with heavy traffic (including pedestrian streets and parking areas for all types of road vehicles).

CLASS E

600 kN / 134,800 lbs. load test = metric 60 tonnes / 66 US tons
Group 5: Areas subjected to extremely heavy vehicles traffic, e.g. fuel stations, industrial and warehouse roadways and loading bays

CLASS F

900 kN / 202,320 lbs. load test = metric 90 tonnes / 99 US tons
Group 6: Areas subjected to very high wheel loads, e.g. docks and airports.



Taurus Channel 130/40 (5" x 1 9/16")

Used for the collection and drainage of rainwater and for the discharge of liquids for industrial use. The HDPE material has an excellent resistance to chemicals and organic agents and it is "self-cleaning". This channel is shock resistant, unbreakable and can guarantee high performances in temperatures from -40°C to 100°C (-40°F to 212°F). Available in black, in different designs and depths

Lateral outlet diameter is 50mm (2"), bottom outlet diameters are 75mm, 100mm (3", 4")

Made of PE-HD (high-density polyethylene).

It can be combined with a wide range of gratings in order to be used in pedestrian areas, driveways, roads and highways.



CHANNELS	FLOW	Slope					
		1 %		2 %		3 %	
		Flow Rates		litres/min.		(gallons/min GPM)	
Taurus 130/40		4.27	56	6.04	80	7.40	98
Taurus 130/75		9.47	132	13.39	177	16.40	229
Taurus 130/150		21.31	281	30.13	397	36.90	487



Code	Product	Size in. (W x D x L)	Size in. (W x D x L)	Pack size	Pallet
POZ92-1304	Taurus 130/40	130 x 40 x 1,000	5 x 1 9/16 x 39 3/8	1 pc.	105 pcs.

Note: Measurements shown above relate to OD's (outside diameters) of pipes

accessories

Code	Product	Size in. (W x D x L)	Size in. (W x D x L)	Pack size	Pallet
POZ95-1304TB	End Caps Set (2 pcs./pack)	130 x 40	5 x 1 9/16	200 pcs.	3,000 pcs.
POZ95-1317	Galvanised Steel Edge Rail	1,000	39 3/8	1 pc.	500 pcs.
POZ95-1307B	Lock System 130 Kit (screws & bolts incl.)	130	5	250 pcs.	4,000 pcs.
POZ95-1318	Stainless Steel Edge Rail	1,000	39 3/8	1 pc.	500 pcs.
POZ95-1319	Gasket for Channel	ø 100 / 110	ø 4 / 4 1/2	250 pcs.	3,750 pcs.



END CAPS SET
POZ95-1304TB



LOCK SYSTEM
POZ95-1307B



**GALVANISED STEEL
EDGE RAIL**
POZ95-1317



**STAINLESS STEEL
EDGE RAIL**
POZ95-1318



GASKET
POZ95-1319

Taurus Channel 130/75 (5" x 3")

Used for the collection and drainage of rainwater and for the discharge of liquids for industrial use. The HDPE material has an excellent resistance to chemicals and organic agents and it is "self-cleaning". This channel is shock resistant, unbreakable and can guarantee high performances in temperatures from -40°C to 100°C (-40°F to 212°F). Available in black, in different designs and depths

Lateral inlet diameter is 63mm (2½"). Bottom outlet diameters are 75mm, 100mm (3", 4") or 110mm (4½") with adaptor POX96-1319. Taurus channels are compatible with reinforcement profile (POZ95-1317). With this profile you can get up to F900 loading capacity.

Made of PE-HD (high-density polyethylene).

It can be combined with a wide range of gratings in order to be used in pedestrian areas, driveways, roads and highways.



CHANNELS	FLOW	Slope					
		1 %		2 %		3 %	
		Flow Rates		litres/min.		(gallons/min GPM)	
Taurus 130/40		4.27	56	6.04	80	7.40	98
Taurus 130/75		9.47	132	13.39	177	16.40	229
Taurus 130/150		21.31	281	30.13	397	36.90	487



Code	Product	Size mm (W x D x L)	Size in. (W x D x L)	Pack size	Pallet
POZ92-1307P	Taurus 130/75	130 x 40 x 1,000	5 x 3 x 39¾	1 pc.	70 pcs.

Note: Measurements shown above relate to OD's (outside diameters) of pipes

accessories

Code	Product	Size mm	Size in.	Pack size	Pallet
POZ95-1307PTB	End Caps Set (3 pcs./pack)	130 x 75	5 x 3	80 pcs.	800 pcs.
POZ95-1317	Galvanised Steel Edge Rail	1,000	39¾	1 pc.	500 pcs.
POZ95-1307B	Lock System 130 Kit (screws & bolts incl.)	130	5	250 pcs.	4,000 pcs.
POZ95-1318	Stainless Steel Edge Rail	130 x 40 x 1,000	5 x 3 x 39¾	1 pc.	500 pcs.
POZ95-1319	Gasket for Channel	ø 100 / 110	ø 4 / 4½	250 pcs.	3,750 pcs.



END CAPS SET
POZ95-1307PTB



LOCK SYSTEM
POZ95-1307B



**GALVANISED STEEL
EDGE RAIL**
POZ95-1317



**STAINLESS STEEL
EDGE RAIL**
POZ95-1318



GASKET
POZ95-1319

Taurus Channel 130/150 (5" x 6")

Used for the collection and drainage of rainwater and for the discharge of liquids for industrial use. The HDPE material has an excellent resistance to chemicals and organic agents and it is "self-cleaning". This channel is shock resistant, unbreakable and can guarantee high performances in temperatures from -40°C to 100°C (-40°F to 212°F). Available in black, in different designs and depths

Lateral inlet diameters are 63mm (2½"). Bottom outlet diameters are 75mm, 110mm (3", 4½"). Taurus channels are compatible with reinforcement profile (POZ95-1317). With this profile you can get up to F900 loading capacity.

Made of PE-HD (high-density polyethylene).

It can be combined with a wide range of gratings in order to be used in pedestrian areas, driveways, roads and highways.



TAURUS 130/150

TAURUS 130/150 with 400 Cast Iron Grating

CHANNELS	FLOW	Slope					
		1 %		2 %		3 %	
		Flow Rates		litres/min.		(gallons/min GPM)	
Taurus 130/40		4.27	56	6.04	80	7.40	98
Taurus 130/75		9.47	132	13.39	177	16.40	229
Taurus 130/150		21.31	281	30.13	397	36.90	487



Code	Product	Size mm (W x D x L)	Size in. (W x D x L)	Pack size	Pallet
POZ92-1315P	Taurus 130/150	130 x 150 x 1,000	5 x 6 x 39⅞	1 pc.	70 pcs.
POZ92-1307P	Taurus 130/150 with D400 Cast Iron Grating	130 x 150 x 1,000	5 x 6 x 39⅞	1 pc.	35 pcs.

Note: Measurements shown above relate to OD's (outside diameters) of pipes

accessories

Code	Product	Size mm	Size in.	Pack size	Pallet
POZ95-1315PTB	End Cap	130 x 150	5 x 6	40 pcs.	1,000 pcs.
POZ95-1310B	Lock System Skat 130 Kit (screws and bolts incl.)	130	5	100 pcs.	3,000 pcs.
POZ95-1315PTG	End Cap for POZ92-1315PGD	130 x 150	5 x 6	40 pcs.	1,200 pcs.
POZ95-1317	Galvanised Steel Edge Rail	1,000	39⅞	1 pc.	500 pcs.



END CAP
POZ95-1315PTB



END CAP
POZ95-1315PTG

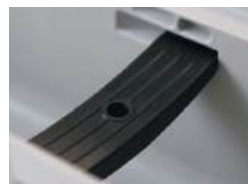

LOCK SYSTEM
POZ95-1310B



GALVANISED
EDGE RAIL
POZ95-1317

Drainage | Taurus 130 Channels with Gratings

Ref.	Code	Product	Size mm (W x D L)	Size in. (W x D L)	Pallet
A15	TAURUS 130 - GALVANISED STEEL GRATING or STAINLESS STEEL GRATING + LOCK SYSTEM				
	POZ90-1304/A	130/40 w/Galvanised Steel Grating	130 x 40 x 1,000	5 x 1 ⁹ / ₁₆ x 39 ¹ / ₃	91 pcs.
	POZ92-1304/B	130/40 w/Stainless Steel Edge Cover Grating	130 x 40 x 1,000	5 x 1 ⁹ / ₁₆ x 39 ¹ / ₃	91 pcs.
	POZ92-1D307P/C	130/75 w/Galvanised Steel Edge Cover Grating	130 x 75 x 1,000	5 x 3 x 39 ¹ / ₃	63 pcs.
	POZ92-1307P/D	130/75 w/Stainless Steel Edge Cover Grating	140 x 75 x 1,000	6 x 3 x 39 ¹ / ₃	63 pcs.
	POZ92-1315P/C	130/150 w/Galvanised Steel Edge Cover Grating	130 x 150 x 1,000	5 x 6 x 39 ¹ / ₃	35 pcs.
POZ92-1315P/D	130/150 w/Stainless Steel Edge Cover Grating	130 x 150 x 1,000	5 x 6 x 39 ¹ / ₃	35 pcs.	
A15	TAURUS 130 - GALVANISED or STAINLESS STEEL EDGE COVER GRATING + LOCK SYSTEM				
	POZ92-1304/C	130/40 w/Galvanised Steel Edge Cover Grating	130 x 40 x 1,000	5 x 1 ⁹ / ₁₆ x 39 ¹ / ₃	91 pcs.
	POZ92-1304/B	130/40 w/Stainless Steel Edge Cover Grating	130 x 40 x 1,000	5 x 1 ⁹ / ₁₆ x 39 ¹ / ₃	91 pcs.
	POZ92-1D307P/C	130/75 w/Galvanised Steel Edge Cover Grating	130 x 75 x 1,000	5 x 3 x 39 ¹ / ₃	63 pcs.
	POZ92-1307P/D	130/75 w/Stainless Steel Edge Cover Grating	140 x 75 x 1,000	6 x 3 x 39 ¹ / ₃	63 pcs.
	POZ92-1315P/C	130/150 w/Galvanised Steel Edge Cover Grating	130 x 150 x 1,000	5 x 6 x 39 ¹ / ₃	35 pcs.
POZ92-1315P/D	130/150 w/Stainless Steel Edge Cover Grating	130 x 150 x 1,000	5 x 6 x 39 ¹ / ₃	35 pcs.	
B125	TAURUS 130 - ANTI-HEEL GALVANISED STEEL GRATING + LOCK SYSTEM				
	POZ92-1304/E	130/40 with B125 Anti-heel Grating	130 x 40 x 1,000	5 x 1 ⁹ / ₁₆ x 39 ¹ / ₃	91 pcs.
	POZ92-1307P/E	130/75 with B125 Anti-heel Grating	130 x 75 x 1,000	5 x 3 x 39 ¹ / ₃	63 pcs.
	POZ92-1315P/E	130/150 with B125 Anti-heel Grating	130 x 150 x 1,000	5 x 6 x 39 ¹ / ₃	35 pcs.
B125	TAURUS 130 - B125 33 x 33 GALVANISED STEEL GRATING + LOCK SYSTEM				
	POZ92-1304/F	130/40 with B125 1 ¹ / ₃ " x 1 ¹ / ₃ " Mesh Grating	130 x 40 x 1,000	5 x 1 ⁹ / ₁₆ x 39 ¹ / ₃	91 pcs.
	POZ92-1307P/F	130/75 with B125 1 ¹ / ₃ " x 1 ¹ / ₃ " Mesh Grating	130 x 75 x 1,000	5 x 3 x 39 ¹ / ₃	63 pcs.
	POZ92-1315P/F	130/150 with B125 1 ¹ / ₃ " x 1 ¹ / ₃ " Mesh Grating	130 x 150 x 1,000	5 x 6 x 39 ¹ / ₃	35 pcs.
B125	TAURUS 130 - B125 CAST IRON GRATING + LOCK SYSTEM				
	POZ92-1304/L	130/40 with B125 Cast Iron Grating	130 x 40 x 1,000	5 x 1 ⁹ / ₁₆ x 39 ¹ / ₃	91 pcs.
	POZ92-1307P/L	130/75 with B125 Cast Iron Grating	130 x 75 x 1,000	5 x 3 x 39 ¹ / ₃	63 pcs.
	POZ92-1315P/L	130/150 with B125 Cast Iron Grating	130 x 150 x 1,000	5 x 6 x 39 ¹ / ₃	35 pcs.
B125	TAURUS 130 - B 125 ANTI-HEEL CAST IRON GRATING + LOCK SYSTEM				
	POZ92-1304/H	130/40 with Anti-Heel Cast Iron Grating	130 x 40 x 1,000	5 x 1 ⁹ / ₁₆ x 39 ¹ / ₃	91 pcs.
	POZ92-1307P/H	130/75 with Anti-Heel Cast Iron Grating	130 x 75 x 1,000	5 x 3 x 39 ¹ / ₃	63 pcs.
	POZ92-1315P/H	130/150 with Anti-Heel Cast Iron Grating	130 x 150 x 1,000	5 x 6 x 39 ¹ / ₃	35 pcs.
B125	TAURUS 130 - B 125 33 x 33 GALVANISED STEEL GRATING				
	POZ92-1304/O	130/40 with Anti-Heel Technical Grating	130 x 40 x 1,000	5 x 1 ⁹ / ₁₆ x 39 ¹ / ₃	91 pcs.
	POZ92-1307P/O	130/75 with Anti-Heel Technical Grating	130 x 75 x 1,000	5 x 3 x 39 ¹ / ₃	63 pcs.
	POZ92-1315P/O	130/150 with Anti-Heel Technical Grating	130 x 150 x 1,000	5 x 6 x 39 ¹ / ₃	35 pcs.
C250	TAURUS 130 - 33 x 33 GALVANISED STEEL GRATING + LOCK SYSTEM				
	POZ92-1304/G	130/40 with C250 1 ¹ / ₃ " x 1 ¹ / ₃ " Grating	130 x 40 x 1,000	5 x 1 ⁹ / ₁₆ x 39 ¹ / ₃	91 pcs.
	POZ92-1307P/G	130/75 with C250 1 ¹ / ₃ " x 1 ¹ / ₃ " Grating	130 x 75 x 1,000	5 x 3 x 39 ¹ / ₃	63 pcs.
	POZ92-1315P/G	130/150 with C250 1 ¹ / ₃ " x 1 ¹ / ₃ " Grating	130 x 150 x 1,000	5 x 6 x 39 ¹ / ₃	35 pcs.
C250	TAURUS 130 - C250 CAST IRON GRATING + LOCK SYSTEM				
	POZ92-1304/M	130/40 with C250 Cast Iron Grating	130 x 40 x 1,000	5 x 1 ⁹ / ₁₆ x 39 ¹ / ₃	91 pcs.
	POZ92-1307P/M	130/75 with C250 Cast Iron Grating	130 x 75 x 1,000	5 x 3 x 39 ¹ / ₃	63 pcs.
	POZ92-1315P/M	130/150 with C250 Cast Iron Grating	130 x 150 x 1,000	5 x 6 x 39 ¹ / ₃	35 pcs.
C250	TAURUS 130 - C250 ANTI-HEEL CAST IRON GRATING + LOCK SYSTEM				
	POZ92-1304/I	130/40 with C250 Anti-Heel Grating	130 x 40 x 1,000	5 x 1 ⁹ / ₁₆ x 39 ¹ / ₃	91 pcs.
	POZ92-1307P/I	130/75 with C250 Anti-Heel Grating	130 x 75 x 1,000	5 x 3 x 39 ¹ / ₃	63 pcs.
	POZ92-1315P/I	130/150 with C250 Anti-Heel Grating	130 x 150 x 1,000	5 x 6 x 39 ¹ / ₃	35 pcs.
C250	TAURUS 130 - C250 ANTI-HEEL TECHNICAL POLYMER GRATING + LOCK SYSTEM				
	POZ92-1304/N	130/40 with C250 Anti-Heel Technical Grating	130 x 40 x 1,000	5 x 1 ⁹ / ₁₆ x 39 ¹ / ₃	91 pcs.
	POZ92-1307P/N	130/75 with C250 Anti-Heel Technical Grating	130 x 75 x 1,000	5 x 3 x 39 ¹ / ₃	63 pcs.
	POZ92-1315P/N	130/150 with C250 Anti-Heel Technical Grating	130 x 150 x 1,000	5 x 6 x 39 ¹ / ₃	35 pcs.
D400	TAURUS 130 - D400 CAST IRON GRATING + LOCK SYSTEM				
	POZ92-1315PGD	130/150 with D400 Cast Iron Grating	130 x 150 x 1,000	5 x 6 x 39 ¹ / ₃	35 pcs.

Drainage | Taurus 130 Gratings

Ref.	Code	Product	Material	Size mm	Size in.	Pallet
A15						
	POZ90-1351XS	Extra Strong Grating 130	PP	130 x 500	5 x 19 ³ / ₄	630 pcs.
	POZ90-1351XSN	Black Extra Strong Grating 130	PP	130 x 500	5 x 19 ³ / ₄	630 pcs.
	POZ90-1351	Anti-heel Strong Grating 130	PP	130 x 500	5 x 19 ³ / ₄	850 pcs.
	POZ90-1351S	Strong Grating 130	PP	130 x 500	5 x 19 ³ / ₄	680 pcs.
	POZ90-1351SN	Black Strong Grating 130	PP	130 x 500	5 x 19 ³ / ₄	680 pcs.
	POZ90-1352	Cover 130	PP	130 x 500	5 x 19 ³ / ₄	680 pcs.
	POZ90-1351P	Swimming Pool Grating 130	ABS	130 x 500	5 x 19 ³ / ₄	700 pcs.
	POZ90-1351FN	Black slot grating	PP	130 x 500	5 x 19 ³ / ₄	240 pcs.
	POZ90-1351ZCB	Edge Cover Grating 130	Galvanised Steel	150 x 1,000	6 x 39 ³ / ₈	588 pcs.
	POZ90-1351ZICB	Edge Cover Grating 130	Stainless Steel	150 x 1,000	6 x 39 ³ / ₈	504 pcs.
	POZ90-1351Z	Grating for Taurus 130	Galvanised Steel	130 x 1,000	5 x 39 ³ / ₈	560 pcs.
	POZ90-1351ZIT	Grating for Taurus 130	Stainless Steel	130 x 1,000	5 x 39 ³ / ₈	560 pcs.
	POZ90-1351ZA1T	Anti-heel Grating 130	Galvanised Steel	130 x 1,000	5 x 39 ³ / ₈	560 pcs.
B125						
	POZ90-1351ZB1T	Grating for Taurus 130	Galvanised Steel	130 x 1,000	5 x 39 ³ / ₈	560 pcs.
	POZ90-1351ZBA	Anti-heel Grating 130	Galvanised Steel	130 x 1,000	5 x 39 ³ / ₈	378 pcs.
	POZ90-1351ZBQ	Grating 130 - mesh 33 x 33	Galvanised Steel	130 x 1,000	5 x 39 ³ / ₈	378 pcs.
	POZ90-1351GBN	Grating 130	Cast Iron	130 x 500	5 x 19 ³ / ₄	280 pcs.
	POZ90-1351HB	Anti-heel Grating 130	Cast Iron	130 x 500	5 x 19 ³ / ₄	260 pcs.
	POZ90-1951	Anti-heel Technical Polymer 130 Grating for Taurus	PP	130 x 500	5 x 19 ³ / ₄	540 pcs.
C250						
	POZ90-1351ZC2T	Grating for Taurus 130	Galvanised Steel	130 x 1,000	5 x 39 ³ / ₈	560 pcs.
	POZ90-1351ZCQ	Grating 130 - mesh 33 x 33	Galvanised Steel	130 x 1,000	5 x 39 ³ / ₈	288 pcs.
	POZ90-1351GC	Slotted Grating 130	Cast Iron	130 x 500	5 x 19 ³ / ₄	250 pcs.
	POZ90-1351GCN	Grating for Taurus 130	Cast Iron	130 x 500	5 x 19 ³ / ₄	280 pcs.
	POZ90-1351HC	Anti-heel Grating 130	Cast Iron	130 x 500	5 x 19 ³ / ₄	260 pcs.
	POZ90-1952	Anti-heel Technical Polymer Grating for Taurus 130	PA + 30% Fiber Glass	130 x 500	5 x 19 ³ / ₄	540 pcs.
D400						
	POZ90-1351GDN	D400 Grating 130	Cast Iron	130 x 500	5 x 19 ³ / ₄ "	280 pcs.

Taurus Channel 200/40 (8" x 1 9/16")

Used for the collection and drainage of rainwater and for the discharge of liquids for industrial use. The HDPE material has an excellent resistance to chemicals and organic agents and it is "self-cleaning". This channel is shock resistant, unbreakable and can guarantee high performances in temperatures from -40°C to 100°C (-40°F to 212°F). Available in black, in different designs and depths.

Lateral outlet diameter is 50mm (2"), bottom outlet diameters are 110mm, 140mm (4 1/3", 5 1/2"). When this Taurus Channel is configured with reinforcing edge rails it should be matched with the POZ95-1317 profile to allow loads up to D400.

Made of PE-HD (high-density polyethylene).

It can be combined with a wide range of gratings in order to be used in pedestrian areas, driveways, roads and highways.



CHANNELS	FLOW	Slope					
		1 %		2 %		3 %	
		Flow Rates		litres/min.		(gallons/min GPM)	
Taurus 200/40		6.86	90	9.70	128	11.88	157
Taurus 200/75		16.13	213	22.81	301	27.93	369
Taurus 200/150		38.38	507	54.28	716	66.47	877



Code	Product	Size mm (W x D x L)	Size in. (W x D x L)	Pack size	Pallet
POZ92-2004P	Taurus 200/40 with Edge	200 x 40 x 1,000	8 x 1 9/16 x 39 3/8	1 pc.	70 pcs.
POZ92-2004PPG	Taurus 200/40 Configured for the Edge Rail	200 x 40 x 1,000	8 x 1 9/16 x 39 3/8	1 pc.	70 pcs.

Note: Measurements shown above relate to OD's (outside diameters) of pipes

accessories

Code	Product	Size mm	Size in.	Pack size	Pallet
POZ95-2004PT	End Cap	200 x 75	8 x 3	100 pcs.	1,600 pcs.
POZ95-1320BZ	Galvanised Lock System 200 Kit (screws & bolts incl.)	200	8	100 pcs.	2,000 pcs.
POZ95-1320BN	Lock System 200 Kit (screws & bolts incl.)	200	8	100 pcs.	2,000 pcs.
POZ95-1317*	Galvanised Steel Edge Rail	1,000	39 3/8	1 pc.	500 pcs.
POZ95-1317/ZP**	Heavy Galvanised Steel Edge Rail Rail h. 20mm Class B125	1,000	39 3/8	1 pc.	500 pcs.
POZ95-1317ZAN	Anchor Bracket for Edge Rail	130	5	8 pcs.	1,050 pcs.



END CAP
POZ95-2004PT



LOCK SYSTEM 200 KIT
POZ95-1320BZ



GALVANISED EDGE RAIL
POZ95-1317*



HEAVY EDGE RAIL
POZ95-1317/ZP**

* for Taurus with edge
** for Taurus without edge

Taurus Channel 200/75 (8" x 3")

Used for the collection and drainage of rainwater and for the discharge of liquids for industrial use. The HDPE material has an excellent resistance to chemicals and organic agents and it is "self-cleaning". This channel is shock resistant, unbreakable and can guarantee high performances in temperatures from -40°C to 100°C (-40°F to 212°F). Available in black, in different designs and depths.

Lateral outlet diameters are 50mm, 63mm (2", 2½"), bottom outlet diameters are 110mm, 140mm (4⅓", 5½"). When this Taurus Channel is configured with reinforcing edge rails it should be matched with the POZ95-1317 profile to allow loads up to D400.

Made of PE-HD (high-density polyethylene).

It can be combined with a wide range of gratings in order to be used in pedestrian areas, driveways, roads and highways.



CHANNELS	FLOW	Slope					
		1%		2%		3%	
		Flow Rates		liters/min.		(US galls/min GPM)	
Taurus 200/40		6.86	108	9.70	153	11.88	188
Taurus 200/75		16.13	255	22.81	361	27.93	442
Taurus 200/150		38.38	608	54.28	860	66.47	1053



Code	Product	Size mm (W x D x L)	Size in. (W x D x L)	Pack size	Pallet
POZ92-2007P	Taurus 200/75 with Edge	200 x 75 x 1,000	8 x 3 x 39⅞	1 pc.	50 pcs.
POZ92-2007PPG	Taurus 200/75 Configured for the Edge Rail	200 x 75 x 1,000	8 x 3 x 39⅞	1 pc.	50 pcs.

Note: Measurements shown above relate to OD's (outside diameters) of pipes

accessories

Code	Product	Size mm	Size in.	Pack size	Pallet
POZ95-2007PT	End Cap	200 x 75	8 x 3	100 pcs.	1,600 pcs.
POZ95-1320BZ	Galvanised Lock System 200 Kit (screws & bolts incl.)	200	8	100 pcs.	2,000 pcs.
POZ95-1302BN	Lock System 200 Kit (screws & bolts incl.)	200	8	200 pcs.	3,200 pcs.
POZ95-1317*	Galvanised Steel Edge Rail	1,000	39⅞	1 pc.	500 pcs.
POZ95-1317/ZP**	Heavy Galvanised Steel Edge Rail Rail h. 20mm Class B125	1,000	39⅞	1 pc.	500 pcs.
POZ95-1317ZAN	Anchor Bracket for Edge Rail	1,179 x 36	7 x 1⅝	8 pcs.	1,050 pcs.

* for Taurus with edge
** for Taurus without edge



LOCK SYSTEM GALVANISED
POZ95-2007PT



END CAP
POZ95-2007PT



BRACKET
POZ95-1317ZAN

Taurus Channel 200/150 (8" x 6")

Used for the collection and drainage of rainwater and for the discharge of liquids for industrial use. The HDPE material has an excellent resistance to chemicals and organic agents and it is "self-cleaning". This channel is shock resistant, unbreakable and can guarantee high performances in temperatures from -40°C to 100°C (-40°F to 212°F). Available in black, in different designs and depths.

Lateral outlet diameters are 50mm, 63mm (2", 2½"), bottom outlet diameters are 110mm, 140mm (4⅓", 5½"). When this Taurus Channel is configured with reinforcing edge rails it should be matched with the POZ95-1317 profile to allow loads up to D400.

Made of PE-HD (high-density polyethylene).

It can be combined with a wide range of gratings in order to be used in pedestrian areas, driveways, roads and highways.

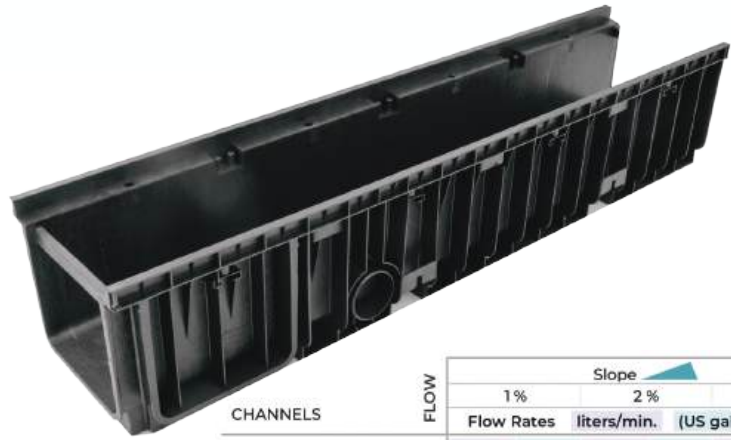

CHANNELS	FLOW	Slope					
		1%		2%		3%	
		Flow Rates		liters/min.		(US galls/min GPM)	
Taurus 200/40		6.86	108	9.70	153	11.88	188
Taurus 200/75		16.13	255	22.81	361	27.93	442
Taurus 200/150		38.38	608	54.28	860	66.47	1053





Code	Product	Size mm (W x D x L)	Size in. (W x D x L)	Pack size	Pallet
POZ92-2015P	Taurus 200/150 with Edge	200 x 150 x 1,000	8 x 6 x 39⅜	1 pc.	50 pcs.
POZ92-2015PPG	Taurus 200/150 Configured for the Edge Rail	200 x 150 x 1,000	8 x 6 x 39⅜	1 pc.	50 pcs.

Note: Measurements shown above relate to OD's (outside diameters) of pipes

accessories

Code	Product	Size mm	Size in.	Pack size	Pallet
POZ95-2015PT	End Cap	200 x 150	8 x 6	80 pcs.	960 pcs.
POZ95-1320BZ	Galvanised Lock System 200 Kit (screws & bolts incl.)	200	8	100 pcs.	2,000 pcs.
POZ95-1320BN	Lock System 200 Kit (screws & bolts incl.)	200	8	200 pcs.	3,200 pcs.
POZ95-1317*	Galvanised Steel Edge Rail	1,000	39⅜	1 pc.	500 pcs.
POZ95-1317/ZP**	Heavy Galvanised Steel Edge Rail Rail h. 20mm Class B125	1,000	39⅜	1 pc.	500 pcs.
POZ95-1317ZAN	Anchor Bracket for Edge Rail	130	5	8 pcs.	1,050 pcs.

* for Taurus with edge ** for Taurus without edge

					
END CAPS SET POZ95-2004PT	LOCK GALVANISED SYSTEM POZ95-2004PT	LOCK SYSTEM KIT POZ95-2004PT	GALVANISED EDGE RAIL POZ95-2004PT	HEAVY EDGE RAIL POZ95-2004PT	BRACKET POZ95-2004PT

Drainage | Taurus 200 Channels with Gratings

Ref.	Code	Product	Size mm (W x D L)	Size in. (W x D L)	Pallet
A15	TAURUS 200 - GALVANISED STEEL GRATING or STAINLESS STEEL GRATING + LOCK SYSTEM				
	POZ92-2004P/A	200/40 w/Galvanised Steel Grating	200 x 40 x 1,000	8 x 1 ⁹ / ₁₆ x 39 ¹ / ₃	70 pcs.
	POZ92-2004P/B	200/40 w/Stainless Steel Grating	200 x 40 x 1,000	8 x 1 ⁹ / ₁₆ x 39 ¹ / ₃	70 pcs.
	POZ92-2007P/A	200/75 w/Galvanised Steel Grating	200 x 75 x 1,000	8 x 3 x 39 ¹ / ₃	50 pcs.
	POZ92-2007P/B	200/75 w/Stainless Steel Grating	140 x 75 x 1,000	5 x 3 x 39 ¹ / ₃	50 pcs.
	POZ92-2015P/A	200/150 w/Galvanised Steel Grating	200 x 150 x 1,000	8 x 6 x 39 ¹ / ₃	25 pcs.
	POZ92-2015P/B	200/150 w/Stainless Steel Grating	200 x 150 x 1,000	8 x 6 x 39 ¹ / ₃	25 pcs.
B125	TAURUS 200 - ANTI-HEEL GALVANISED STEEL GRATING + LOCK SYSTEM				
	POZ92-2004P/E	200/40 with B125 Anti-heel Grating	200 x 40 x 1,000	8 x 1 ⁹ / ₁₆ x 39 ¹ / ₃	70 pcs.
	POZ92-2007P/E	200/75 with B125 Anti-heel Grating	200 x 75 x 1,000	5 x 3 x 39 ¹ / ₃	50 pcs.
	POZ92-2015P/E	200/150 with B125 Anti-heel Grating	200 x 150 x 1,000	8 x 5.9 x 39 ¹ / ₃	25 pcs.
B125	TAURUS 200 - B125 33 x 33 GALVANISED STEEL GRATING				
	POZ92-2004P/F	200/40 with B125 33 x 33 (1 ¹ / ₃ ") Grating	200 x 40 x 1,000	8 x 1 ⁹ / ₁₆ x 39 ¹ / ₃	70 pcs.
	POZ92-2007P/F	200/75 with B125 33 x 33 (1 ¹ / ₃ ") Grating	200 x 75 x 1,000	8 x 3 x 39 ¹ / ₃	50 pcs.
	POZ92-2015P/F	200/150 with B125 33 x 33 (1 ¹ / ₃ ") Grating	200 x 150 x 1,000	8 x 6 x 39 ¹ / ₃	25 pcs.
B125	TAURUS 200 - B125 CAST IRON GRATING + SCREWS AND BOLTS				
	POZ92-2004P/L	200/40 with B125 Cast Iron Grating	200 x 40 x 1,000	8 x 1 ⁹ / ₁₆ x 39 ¹ / ₃	70 pcs.
	POZ92-2007P/L	200/75 with B125 Cast Iron Grating	200 x 75 x 1,000	8 x 3 x 39 ¹ / ₃	50 pcs.
	POZ92-2015P/L	200/150 with B125 Cast Iron Grating	200 x 150 x 1,000	8 x 6 x 39 ¹ / ₃	25 pcs.
B125	TAURUS 200 - B 125 ANTI-HEEL CAST IRON GRATING + LOCK SYSTEM				
	POZ92-2004P/H	200/40 with Anti-Heel Cast Iron Grating	200 x 40 x 1,000	8 x 1 ⁹ / ₁₆ x 39 ¹ / ₃	70 pcs.
	POZ92-2007P/H	200/75 Anti-Heel Cast Iron Grating	200 x 75 x 1,000	8 x 3 x 39 ¹ / ₃	50 pcs.
	POZ92-2015P/H	200/150 with Anti-Heel Cast Iron Grating	200 x 150 x 1,000	8 x 6 x 39 ¹ / ₃	25 pcs.
C250	TAURUS 200 - B125 33 x 33 GALVANISED STEEL GRATING + LOCK SYSTEM				
	POZ92-2004P/G	200/40 with C250 33 x 33 (1 ¹ / ₃ ") Grating	200 x 40 x 1,000	8 x 1 ⁹ / ₁₆ x 39 ¹ / ₃	70 pcs.
	POZ92-2007P/G	200/75 with C250 33 x 33 (1 ¹ / ₃ ") Grating	200 x 75 x 1,000	8 x 3 x 39 ¹ / ₃	50 pcs.
	POZ92-2015P/G	200/150 with C250 33 x 33 (1 ¹ / ₃ ") Grating	200 x 150 x 1,000	8 x 6 x 39 ¹ / ₃	25 pcs.
C250	TAURUS 200 - C250 CAST IRON GRATING + SCREWS AND BOLTS				
	POZ92-2004P/M	200/40 with C250 Cast Iron Grating	200 x 40 x 1,000	8 x 1 ⁹ / ₁₆ x 39 ¹ / ₃	70 pcs.
	POZ92-2007P/M	200/75 with C250 Cast Iron Grating	200 x 75 x 1,000	8 x 3 x 39 ¹ / ₃	50 pcs.
	POZ92-2015P/M	200/150 with C250 Cast Iron Grating	200 x 150 x 1,000	8 x 6 x 39 ¹ / ₃	25 pcs.
C250	TAURUS 200 - C250 ANTI-HEEL CAST IRON GRATING + LOCK SYSTEM				
	POZ92-2004P/I	200/40 with C250 Anti-Heel Grating	200 x 40 x 1,000	8 x 1 ⁹ / ₁₆ x 39 ¹ / ₃	70 pcs.
	POZ92-2007P/I	200/75 with C250 Anti-Heel Grating	200 x 75 x 1,000	8 x 3 x 39 ¹ / ₃	50 pcs.
	POZ92-2015P/I	200/150 with C250 Anti-Heel Grating	200 x 150 x 1,000	8 x 6 x 39 ¹ / ₃	25 pcs.
D400	TAURUS 200 - D400 CAST IRON GRATING + SCREWS & BOLTS + EDGE RAIL + ANCHOR BRACKET				
	POZ92-2004P/N	200/40 with D400 Cast Iron Grating	200 x 40 x 1,000	8 x 1 ⁹ / ₁₆ x 39 ¹ / ₃	70 pcs.
	POZ92-2007P/N	200/75 with D400 Cast Iron Grating	200 x 75 x 1,000	8 x 3 x 39 ¹ / ₃	50 pcs.
	POZ92-2015P/N	200/150 with D400 Cast Iron Grating	200 x 150 x 1,000	8 x 6 x 39 ¹ / ₃	25 pcs.

Drainage | Taurus 200 Gratings

Ref.	Code	Product	Material	Size mm	Size in.	Pallet
A15						
	POZ90-1361XS	Extra Strong Grating 200	PP	200 x 500	8 x 19 ³ / ₄	300 pcs.
	POZ90-1361XSN	Black Extra Strong Grating 200	PP	200 x 500	8 x 19 ³ / ₄	300 pcs.
	POZ90-1361	Anti-heel Strong Grating 200	PP	200 x 500	8 x 19 ³ / ₄	462 pcs.
	POZ90-1362	Cover 200	PP	200 x 500	8 x 19 ³ / ₄	462 pcs.
	POZ90-1361P	Swimming Pool Grating 200	ABS	200 x 500	8 x 19 ³ / ₄	462 pcs.
	POZ90-1361Z	Galvanised Steel Grating 200	Galvanized Steel	200 x 1,000	8 x 39 ³ / ₈	540 pcs.
	POZ90-1361ZI	Stainless Steel Grating 200	Stainless Steel	200 x 1,000	8 x 39 ³ / ₈	540 pcs.
B125						
	POZ90-1361ZBA	Anti-heel Grating 200	Galvanized Steel	200 x 1,000	8 x 39 ³ / ₈	240 pcs.
	POZ90-1361ZBQ	Grating 200 - mesh 33 x 33	Galvanized Steel	200 x 1,000	8 x 39 ³ / ₈	240 pcs.
	POZ90-1361GBN	Grating for Taurus 200	Cast Iron	200 x 500	8 x 19 ³ / ₄	150 pcs.
	POZ90-1361HB	B125 Anti-heel Grating 200	Cast Iron	200 x 500	8 x 19 ³ / ₄	250 pcs.
	POZ90-1861	Grating for Taurus 200	Technical Polymer	200 x 500	8 x 19 ³ / ₄	308 pcs.
C250						
	POZ90-1361ZCQ	Grating 200 - mesh 33 x 33	Galvanized Steel	200 x 1,000	8 x 39 ³ / ₈	204 pcs.
	POZ90-1361GCN	Grating for Taurus 200	Cast Iron	200 x 500	8 x 19 ³ / ₄	150 pcs.
	POZ90-13561HC	Anti-heel Grating 200	Cast Iron	200 x 500	8 x 19 ³ / ₄	250 pcs.
D400						
	POZ90-1361GDN	D400 Grating 200	Cast Iron	200 x 500	8 x 19 ³ / ₄	150 pcs.

Taurus 260 (10") Channels

Used for the collection and drainage of rainwater and for the discharge of liquids for industrial use. These channels can be combined with a wide range of gratings in order to be used in pedestrian areas, driveways, roads, highways, ports and airports.

The HDPE material has an excellent resistance to chemicals and organic agents and it is "self-cleaning". This channel is shock resistant, unbreakable and can guarantee high performances in temperatures from -40°C to 100°C (-40°F to 212°F).

Available only in black, equipped with edge rails, cast iron gratings (with the desired load class) and 8 anchor brackets.

Lateral inlet diameters are 50mm, 63mm (2", 2½"), bottom outlet diameters are 140mm, 160mm (5½", 6½").

Made of PE-HD (high-density polyethylene). The accessories are made of galvanised steel, the gratings are made of cast iron.



TAURUS 260/75
with pre-assembled grating

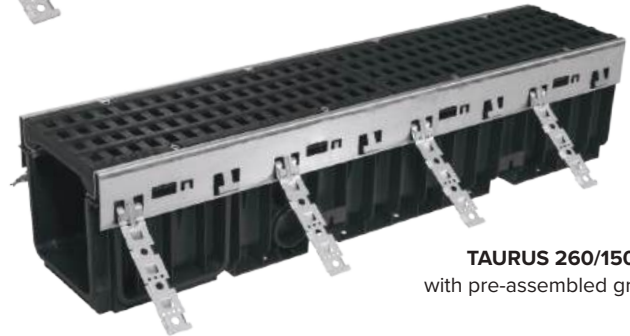

TAURUS 260/150
with pre-assembled grating

Code	Product	Size mm (W x D x L)	Size in. (W x D x L)	Pack size	Pallet
POZ92-2607PD	Taurus 260/75 with Pre-Assembled Grating	260 x 75 x 1,000	10 x 3 x 39¾	1 pc.	36 pcs.
POZ92-2615PD	Taurus 260/150 with Pre-Assembled Grating	260 x 150 x 1,000	10 x 6 x 39¾	1 pc.	20 pcs.

Note: Measurements shown above relate to OD's (outside diameters) of pipes

accessories

Code	Product	Size mm	Size in.	Pack size	Pallet
POZ95-2607PTB	End Caps Set (2 pcs./pack)	260 x 75	10 x 3	100 sets	800 sets
POZ95-2615PTB	End Cap	260 x 150	10 x 6	30 sets	450 sets
POZ95-2600P	PE-HD Bulkhead (connects from a 75mm to 150mm depth Taurus 260 channel)	260 x 75	10 x 3	5 pcs.	-



END CAP
POZ95-2615PTB



LOCK SYSTEM

CHANNELS	FLOW	Slope					
		1 %		2 %		3 %	
		Flow Rates		litres/min.		(gallons/min GPM)	
Taurus 260/75		21.47	283	30.37	401	37.20	491
Taurus 260/150		52.23	689	73.87	975	90.47	1194



EN 1433



EN 1433



EN 1433



EN 1433



EN 1433

Taurus Channel 370/300 (15")

Used for the collection and drainage of rainwater and for the discharge of liquids. These channels are designed for heavy duty usage in industrial applications, highways, ports and airports.

The HDPE material has an excellent resistance to chemicals and organic agents and it is "self-cleaning". This channel is shock resistant, unbreakable and can guarantee high performances in temperatures from -40°C to 100°C (-40°F to 212°F).

Available only in black, equipped with steel reinforcement profiles and pre-assembled with cast iron gratings (the load class is determined by the gratings used).

Lateral inlet diameters are 110mm, 160mm, 200mm (4½", 6½", 8"), bottom outlet diameters are 110mm, 160mm, 200mm (4½", 6½", 8").

Made of PE-HD (high-density polyethylene). The accessories are made of galvanised steel, the gratings are made of cast iron.



THIS MODEL IS SOLD ALREADY EQUIPPED WITH REINFORCED PROFILE AND LOCKING SYSTEM (SCREWS AND BOLTS)

Code	Product	Size mm (W x D x L)	Size in. (W x D x L)	Pack size	Pallet
POZ92-3835E	Taurus 370/30 with Pre-Assembled Grating	370 x 300 x 1,000	15 x 12 x 39¾	1 pc.	12 pcs.

Note: Measurements shown above relate to OD's (outside diameters) of pipes

accessories

Code	Product	Size mm	Size in.	Pack size	Pallet
POZ95-3835PTB	End Caps Set (2 pcs./pack)	370 x 300	15 x 12	5 sets	50 sets



END CAPS SET
POZ95-3835PTB

CHANNELS	FLOW	Slope		
		1%	2%	3%
Taurus 370/300	Flow Rates	litres/min.	(gallons/min GPM)	
		203.85	2,690	288.29
		353.08	4,660	



Pegasus Plus One S 100/35 (4" x 1³/₈")

with plastic gratings

Used for the collection and drainage of rainwater. The Pegasus Plus One S is a specially designed ultra-slim channel, available in a range of colours complete with matching gratings, for use across garage entrances, in patios and other areas around the home. Also available with galvanised or stainless steel gratings in a variety of patterns.

Made to the EN1433 standards, Pegasus Plus One S channels are made of PP (polypropylene), engineered and reinforced to be highly resistant. Colours in stock: grey and black. These channels, on specific request, are also available in sand or white.

These channels, with pre-mounted gratings, can be used in pedestrian or light traffic areas.

Lateral inlet diameter is 32mm (1¹/₄"), bottom outlets are 40mm, 63mm (1⁵/₈", 2¹/₂").

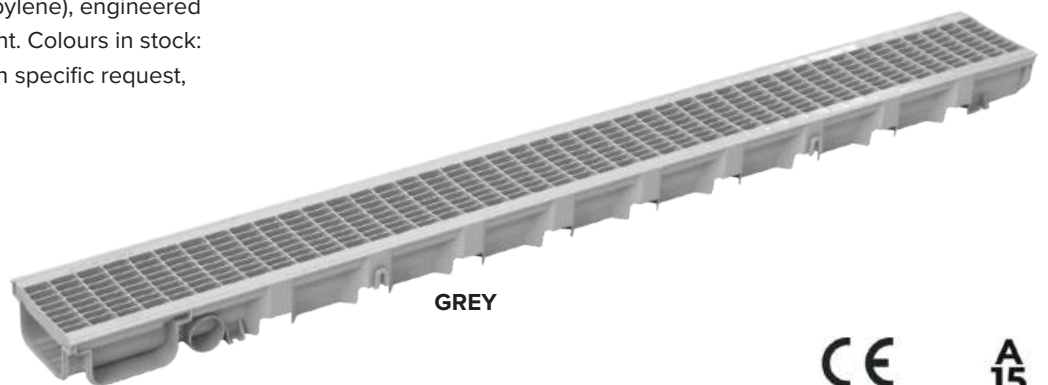

CHANNELS	FLOW	Slope					
		1 %		2 %		3 %	
		Flow Rates		litres/min.		(gallons/min GPM)	
Pegasus Plus One S 100/35		1.93	25	2.73	36	3.35	44

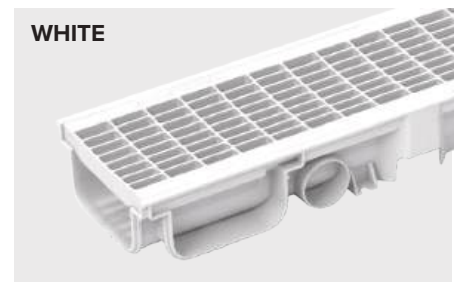
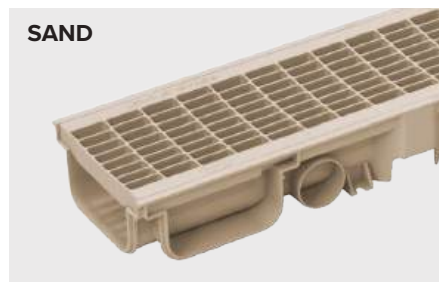

Code	Product	Size mm (W x D x L)	Size in. (W x D x L)	Pack size	Pallet
POZ95-1335P	Pegasus Plus One S with Grating - Grey	130 x 35 x 1,000	4 x 1 ³ / ₈ x 39 ³ / ₈	1 pc.	242 pcs.
POZ90-1335PN	Pegasus Plus One S with Grating - Black	130 x 35 x 1,000	4 x 1 ³ / ₈ x 39 ³ / ₈	1 pc.	242 pcs.
POZ90-1335PS	Pegasus Plus One S with Grating - Sand	130 x 35 x 1,000	4 x 1 ³ / ₈ x 39 ³ / ₈	1 pc.	242 pcs.
POZ90-1335PB	Pegasus Plus One S with Grating - White	130 x 35 x 1,000	4 x 1 ³ / ₈ x 39 ³ / ₈	1 pc.	242 pcs.

Note: Measurements shown above relate to OD's (outside diameters) of pipes

Pegasus Plus One S 100/35 (4" x 1 3/8")

with galvanised steel gratings

Used for the collection and drainage of rainwater. The Pegasus Plus One S is a specially designed ultra-slim channel, available in a range of colours complete with matching gratings, for use across garage entrances, in patios and other areas around the home. Also available with galvanised or stainless steel gratings in a variety of patterns.

Made to the EN1433 standards, Pegasus Plus One S channels are made of PP (polypropylene), engineered and reinforced to be highly resistant.

Colours in stock: grey and black. These channels, on specific request, are also available in sand or white.

For rainwater collection and drainage. The use of stainless steel and galvanised gratings also makes these channels ideal for bathrooms, around pools, locker rooms and for the food industry.



CHANNELS	FLOW	Slope		
		1%	2%	3%
		Flow Rates	litres/min.	(gallons/min GPM)
Pegasus Plus One S 100/35		1.93	25	2.73 36 3.35 44



Code	Product	Size mm (W x D x L)	Size in. (W x D x L)	Pack size	Pallet
POZ90-1335P/Z1	Pegasus Plus One S with Galvanised Steel 'Wave More' Grating - Grey	130 x 35 x 1,000	4 x 1 3/8 x 39 3/8	1 pc.	242 pcs.
POZ90-1335PN/Z1	Pegasus Plus One S with Galvanised Steel 'Wave More' Grating - Black	130 x 35 x 1,000	4 x 1 3/8 x 39 3/8	1 pc.	242 pcs.
POZ90-1335P/Z3	Pegasus Plus One S with Galvanised Steel 'Hole' pattern Grating - Grey	130 x 35 x 1,000	4 x 1 3/8 x 39 3/8	1 pc.	242 pcs.
POZ90-1335PN/Z3	Pegasus Plus One S with Galvanised Steel 'Hole' pattern Grating - Grey	130 x 35 x 1,000	4 x 1 3/8 x 39 3/8	1 pc.	242 pcs.
POZ90-1335P/2	Pegasus Plus One S with Galvanised Steel 'Wave Less' Grating - Grey	130 x 35 x 1,000	4 x 1 3/8 x 39 3/8	1 pc.	242 pcs.
POZ90-1335PN/Z3	Pegasus Plus One S with Galvanised Steel 'Wave Less' Grating - Black	130 x 35 x 1,000	4 x 1 3/8 x 39 3/8	1 pc.	242 pcs.

Note: Measurements shown above relate to OD's (outside diameters) of pipes

Pegasus Plus One S 100/35 (4" x 1 1/2")

with stainless steel gratings

Used for the collection and drainage of rainwater. The Pegasus Plus One S is a specially designed ultra-slim channel, available in a range of colours complete with matching gratings, for use across garage entrances, in patios and other areas around the home. Available with stainless steel gratings in a variety of patterns.

Made to the EN1433 standards, Pegasus Plus One S channels are made of PP (polypropylene), engineered and reinforced to be highly resistant.

Colours in stock: grey and black. These channels, on specific request, are also available in sand or white color.

For rainwater collection and drainage. The use of stainless and galvanized gratings also makes these channels ideal for bathrooms, around pools, locker rooms and for the food industry.



CHANNELS	FLOW	Slope					
		1 %	2 %	3 %			
		Flow Rates litres/min.		Flow Rates (gallons/min GPM)			
Pegasus Plus One S 100/35		1.93	25	2.73	36	3.35	44



Code	Product	Size mm (W x D x L)	Size in. (W x D x L)	Pack size	Pallet
POZ90-1335P/1	Pegasus Plus One S with Stainless Steel 'Wave More' Grating - Grey	130 x 35 x 1,000	4 x 1 1/2 x 39 1/2	1 pc.	242 pcs.
POZ90-1335PN/1	Pegasus Plus One S with Stainless Steel 'Wave More' Grating - Black	130 x 35 x 1,000	4 x 1 1/2 x 39 1/2	1 pc.	242 pcs.
POZ90-1335P/3	Pegasus Plus One S with Stainless Steel 'Hole' pattern Grating - Grey	130 x 35 x 1,000	4 x 1 1/2 x 39 1/2	1 pc.	242 pcs.
POZ90-1335PN/3	Pegasus Plus One S with Stainless Steel 'Hole' grating - Black	130 x 35 x 1,000	4 x 1 1/2 x 39 1/2	1 pc.	242 pcs.
POZ90-1335P/2	Pegasus Plus One S with Stainless Steel 'Wave Less' Grating - Grey	130 x 35 x 1,000	4 x 1 3/8 x 39 3/8	1 pc.	242 pcs.
POZ90-1335PN/2	Pegasus Plus One S with Stainless Steel 'Wave Less' Grating - Black	130 x 35 x 1,000	4 x 1 3/8 x 39 3/8	1 pc.	242 pcs.

Note: Measurements shown above relate to OD's (outside diameters) of pipes

Pegasus Plus 130/75 (5" x 3")

Used for the collection and drainage of rainwater. The Pegasus Plus 130 line is available in a range of colours for use across garage entrances, driveways, patios, pool side, locker rooms and other areas with pedestrian and low density traffic applications. Available with plastic, cast iron, galvanised or stainless steel gratings in a variety of patterns to suit every requirement.

Made to the EN1433 standards, Pegasus 130 channels are made of PP (polypropylene), engineered and reinforced to be highly resistant.

These channels are available in grey, black, sand (special order only) and white. They are manufactured to meet or exceed the EN1433 standards A15, B125 and C250 (subject to the grating being used) for pedestrian or light traffic areas. Bottom outlets are 75mm, 100 mm (3", 4") (all colours) or 75mm, 110mm (3", 4½") (grey, black).



CHANNELS	FLOW	Slope					
		1%		2%		3%	
		Flow Rates		litres/min.		(gallons/min GPM)	
Pegasus Plus 130/75		5.75	76	8.13	107	9.95	131
Pegasus Plus 130/120		11.78	155	16.66	220	20.40	269

Code	Product	Size mm (W x D x L)	Size in. (W x D x L)	Pack size	Pallet
POZ91-1300P	Pegasus Plus - Grey	130 x 75 x 1,000	5 x 3 x 39¾	24 pcs.	96 pcs.
POZ91-1300PN	Pegasus Plus - Black	130 x 75 x 1,000	5 x 3 x 39¾	24 pcs.	96 pcs.
POZ91-1300PS	Pegasus Plus - Sand	130 x 75 x 1,000	5 x 3 x 39¾	24 pcs.	96 pcs.
POZ91-1300PB	Pegasus Plus - White	130 x 75 x 1,000	5 x 3 x 39¾	24 pcs.	96 pcs.

Note: Measurements shown above relate to OD's (outside diameters) of pipes

accessories

Code	Product	Size mm	Size in.	Pack size	Pallet
POZ95-1300PM	End Caps Set (2 pcs./pack) for Pegasus Plus - Grey	100 x 35	4 x 1¾	200 sets	4,000 sets
POZ95-1300PMN	End Caps Set (2 pcs./pack) for Pegasus Plus - Black	100 x 35	4 x 1¾	200 sets	4,000 sets
POZ95-1300PMS	End Caps Set (2 pcs./pack) for Pegasus Plus - Sand	100 x 35	4 x 1¾	200 sets	4,000 sets
POZ95-1300PMB	End Caps Set (2 pcs./pack) for Pegasus Plus - White	100 x 35	4 x 1¾	200 sets	4,000 sets
POZ95-1307B	Lock System 130 Kit (screws & bolts incl.)	-	-	250 pcs.	4,000 pcs.
POZ95-1319	Gasket for Channel	ø 100 / 110	ø 4 / 4½	250 pcs.	3,750 pcs.
POZ95-1321 (N)	Pipe Connection - Grey (Black)	ø 100	ø 4	100 pcs.	2,000 pcs.



END CAPS SET



LOCK SYSTEM
POZ95-1307B



PIPE
CONNECTION
POZ95-1321 (N)



GASKET FOR
CHANNEL
POZ95-1319

Pegasus Plus 130/120 (5" x 4³/₄")

Used for the collection and drainage of rainwater. The Pegasus Plus 130 line is available in a range of colours for use across garage entrances, driveways, patios, pool side, locker rooms and other areas with pedestrian and low density traffic applications. Available with plastic, cast iron, galvanised or stainless steel gratings in a variety of patterns to suit every requirement.

Made to the EN1433 standards, Pegasus 130 channels are made of PP (polypropylene), engineered and reinforced to be highly resistant.

These channels are available in grey, black, sand (special order only) and white. They are manufactured to meet or exceed the EN1433 standards A15, B125 and C250 (subject to the grating being used) for pedestrian or light traffic areas. Bottom outlets are 75, 110mm (3", 4¹/₂").



CHANNELS	FLOW	Slope			Flow Rates	
		1 %	2 %	3 %	litres/min.	(gallons/min GPM)
Pegasus Plus 130/75		5.75	76	8.13	107	9.95 131
Pegasus Plus 130/120		11.78	155	16.66	220	20.40 269



Code	Product	Size mm (W x D x L)	Size in. (W x D x L)	Pack size	Pallet
POZ90-1310P	Pegasus Plus - Grey	130 x 120 x 1,000	5 x 4 ³ / ₄ x 39 ³ / ₈	24 pcs.	112 pcs.
POZ90-1310PN	Pegasus Plus - Black	130 x 120 x 1,000	5 x 4 ³ / ₄ x 39 ³ / ₈	24 pcs.	112 pcs.
POZ90-1310PS	Pegasus Plus - Sand	130 x 120 x 1,000	5 x 4 ³ / ₄ x 39 ³ / ₈	24 pcs.	112 pcs.
POZ90-1310PB	Pegasus Plus - White	130 x 120 x 1,000	5 x 4 ³ / ₄ x 39 ³ / ₈	24 pcs.	112 pcs.

Note: Measurements shown above relate to OD's (outside diameters) of pipes

accessories

Code	Product	Size mm	Size in.	Pack size	Pallet
POZ95-1310T	End Caps Set (2 pcs./pack) for Pegasus Plus - Grey	100 x 35	4 x 1 ³ / ₈	50 sets	750 sets
POZ95-1310TN	End Caps Set (2 pcs./pack) for Pegasus Plus - Black	100 x 35	4 x 1 ³ / ₈	50 sets	750 sets
POZ95-1310TS	End Caps Set (2 pcs./pack) for Pegasus Plus - Sand	100 x 35	4 x 1 ³ / ₈	50 sets	750 sets
POZ95-1310TB	End Caps Set (2 pcs./pack) for Pegasus Plus - White	100 x 35	4 x 1 ³ / ₈	50 sets	750 sets
POZ95-1310B	Lock System Skat 130 Kit (screws & bolts included)	-	-	100 pcs.	3,000 pcs.





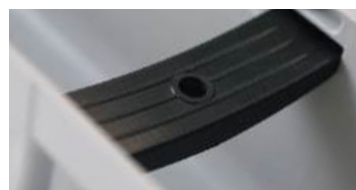





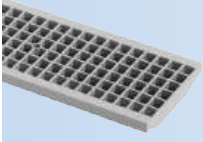



END CAPS SET



LOCK SYSTEM

Drainage | Pegasus 130 Grating

Ref.	Code	Product	Material	Size mm	Size in.	Pallet
A15						
	POZ90-1351CL	Extra Strong Grating with clip 130 - Grey	PP	130 x 1,000	5 x 39 $\frac{3}{8}$	340 pcs.
	POZ90-1351NCL	Extra Strong Grating with clip 130 - Black	PP	130 x 1,000	5 x 39 $\frac{3}{8}$	340 pcs.
	POZ90-1351SCL	Extra Strong Grating with clip 130 - Sand*	PP	130 x 1,000	5 x 39 $\frac{3}{8}$	340 pcs.
	POZ90-1351BCL	Extra Strong Grating with clip 130 - White	PP	130 x 1,000	5 x 39 $\frac{3}{8}$	340 pcs.
	POZ90-1351XS	Gray Extra Strong Grating 130	PP	130 x 500	5 x 19 $\frac{3}{4}$	630 pcs.
	POZ90-1351XSN	Black Extra Strong Grating 130	PP	130 x 500	5 x 19 $\frac{3}{4}$	630 pcs.
	POZ90-1351	Anti-heel Strong Grating 130	PP	130 x 500	5 x 19 $\frac{3}{4}$	850 pcs.
	POZ90-1351S	Strong Grating 130	PP	130 x 500	5 x 19 $\frac{3}{4}$	680 pcs.
	POZ90-1351SN	Black Strong Grating 130	PP	130 x 500	5 x 19 $\frac{3}{4}$	680 pcs.
	POZ90-1352	Cover 130	PP	130 x 500	5 x 19 $\frac{3}{4}$	680 pcs.
	POZ90-1351FN	Black Slot Grating	PP	130 x 500	5 x 19 $\frac{3}{4}$	240 pcs.
	POZ90-1351P	Swimming Pool Grating 130	ABS	130 x 500	5 x 19 $\frac{3}{4}$	700 pcs.
	POZ90-1351ZCL	Grating with Clip 130	Galvanised Steel	130 x 1,000	5 x 39 $\frac{3}{8}$	560 pcs.
	POZ90-1351Z	Grating for Pegasus 130	Galvanised Steel	130 x 1,000	5 x 39 $\frac{3}{8}$	560 pcs.
	POZ90-1351ZA1	Anti-heel Grating 130	Galvanised Steel	130 x 1,000	5 x 39 $\frac{3}{8}$	560 pcs.
	POZ90-1351ZI	Grating for Pegasus 130	Stainless Steel	130 x 1,000	5 x 39 $\frac{3}{8}$	560 pcs.
B125						
	POZ90-1351ZB1	Anti-heel Grating 130	Galvanised Steel	130 x 1,000	5 x 39 $\frac{3}{8}$	560 pcs.
	POZ90-1351ZBA	Anti-heel Grating 130	Galvanised Steel	130 x 1,000	5 x 39 $\frac{3}{8}$	378 pcs.
	POZ90-1351ZBQ	Grating 130 - mesh 33 x 33	Galvanised Steel	130 x 1,000	5 x 39 $\frac{3}{8}$	378 pcs.
	POZ90-1351GBN	Grating 130	Cast Iron	130 x 500	5 x 19 $\frac{3}{4}$	280 pcs.
	POZ90-1351HB	Anti-heel Grating 130	Cast Iron	130 x 500	5 x 19 $\frac{3}{4}$	60 pcs.
	POZ90-1951	Anti-heel Technical Polymer Grating for Taurus 130	PP	130 x 500	5 x 19 $\frac{3}{4}$	540 pcs.
C250						
	POZ90-1351ZC2	Grating for Pegasus 130	Galvanised Steel	130 x 1,000	5 x 39 $\frac{3}{8}$	560 pcs.
	POZ90-1351ZCQ	Grating 130 - mesh 33 x 33	Galvanised Steel	130 x 1,000	5 x 39 $\frac{3}{8}$	288 pcs.
	POZ90-1351GC	Slotted Grating 130	Cast Iron	130 x 500	5 x 19 $\frac{3}{4}$	250 pcs.
	POZ90-1351GCN	Grating for Pegasus 130	Cast Iron	130 x 500	5 x 19 $\frac{3}{4}$	280 pcs.
	POZ90-1351HC	Anti-heel Grating 130	Cast Iron	130 x 500	5 x 19 $\frac{3}{4}$	260 pcs.
	POZ90-1952	Anti-heel Technical Polymer Grating for Taurus 130	In PA + 30% fiber glass	130 x 500	5 x 19 $\frac{3}{4}$	540 pcs.

Pegasus Short Channel 130 (5")

Used for the collection and drainage of rainwater. The Pegasus Short range is easy to handle and is particularly suited for smaller projects like garage entrances, patios and other areas where longer runs of drainage are not required. Available in grey only with gratings in a variety of patterns to suit requirements.

Pegasus Short channels are made of PP (polypropylene), engineered and reinforced to be highly resistant.

Bottom outlets: 130/40, 130/75 - 50mm, 75mm (2", 3"); 130/140 - 50mm (2").

Suitable for use in pedestrian or low density traffic areas with its matched sets of gratings.



CHANNELS	FLOW	Slope					
		1 %		2 %		3 %	
		Flow Rates		litres/min.		(gallons/min GPM)	
Pegasus Short 130/40		2.81	37	3.98	52	4.87	64
Pegasus Short 130/75		6.04	80	8.54	113	10.46	138
Pegasus Short 130/140		16.26	215	23.00	304	28.17	372

Code	Product	Size mm (W x D x L)	Size in. (W x D x L)	Pack size	Pallet
POZ91-1300A	Pegasus Short 130/40 - Grey	130 x 40 x 500	5 x 1 ⁵ / ₁₆ x 19 ³ / ₄	65 pcs.	520 pcs.
POZ91-1300	Pegasus Short 130/75 - Grey	130 x 75 x 500	5 x 3 x 19 ³ / ₄	40 pcs.	320 pcs.
POZ90-1440	Pegasus Short 130/140 - Grey	130 x 140 x 500	5 x 5 ¹ / ₂ x 19 ³ / ₄	24 pcs.	192 pcs.

Note: Measurements shown above relate to OD's (outside diameters) of pipes

accessories

Code	Product	Size mm	Size in.	Pack size	Pallet
POZ95-1300AT	Open End Cap - h.40	130 x 40	5 x 1 ⁵ / ₁₆	350 pcs.	4,500 pcs.
POZ95-1300ATC	Closed End Cap - h.40	130 x 40	5 x 1 ⁵ / ₁₆	450 pcs.	6,750 pcs.
POZ95-1300T	End Cap Set - h.75	130 x 75	5 x 3	250 pcs.	2,500 pcs.
POZ90-1443	End Cap Set - h.140	130 x 140	5 x 5 ¹ / ₂	50 pcs.	-
POZ95-1307B	Lock System Kit for 130/40 & 130/75	-	-	250 pcs.	4,000 pcs.
POZ90-1359	Lock System Kit for 130/40 only	-	-	900 pcs.	-



130 x 40



130 x 75



130 x 140



OPEN END CAP H.40
CLOSED END CAP H.40



END CAPS SET H.75



END CAPS SET H.140

Pegasus Short 200/165 & 200/175 Heavy (8" x 6½")

Used for the collection and drainage of rainwater. The Pegasus Short range is easy to handle and is particularly suited for smaller projects like garage entrances, patios and other areas where longer runs of drainage are not required. Available in grey only with gratings in a variety of patterns to suit requirements.

Pegasus Short channels are made of PP (polypropylene), engineered and reinforced to be highly resistant.

Bottom outlets: 200/165 - 63mm, 74mm (2½", 3"); 200/175 - 75mm, 100mm, 110mm (3", 4", 4⅓").

Suitable for use in pedestrian or low density traffic areas with its matched sets of gratings.

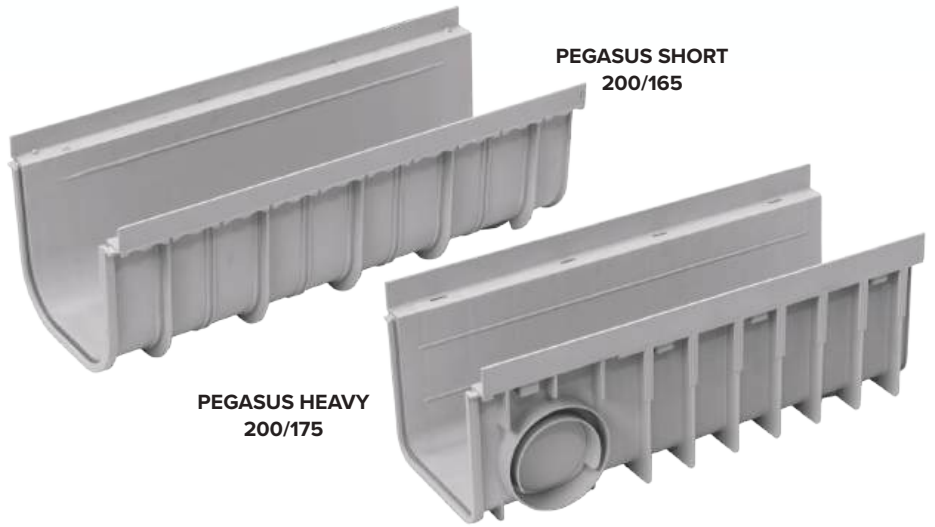

CHANNELS	FLOW	Slope					
		1%		2%		3%	
		Flow Rates	litres/min.	litres/min.	gallons/min GPM	litres/min.	gallons/min GPM
Pegasus Short 200/145		35.85	473	50.70	669	62.10	819
Pegasus Short 200/165		36.67	484	51.86	684	63.51	838

Code	Product	Size mm (W x D x L)	Size in. (W x D x L)	Pack size	Pallet
POZ80-1364	Pegasus Short 200/165 - Grey	200 x 165 x 500	8 x 6½ x 19¾	12 pcs.	96 pcs.
POZ80-1364H	Pegasus Heavy 200/175 - Grey	200 x 175 x 500	8 x 6⅞ x 19¾	12 pcs.	96 pcs.

Note: Measurements shown above relate to OD's (outside diameters) of pipes

accessories

Code	Product	Size mm	Size in.	Pack size	Pallet
POZ90-1366	End CapSet	h. 165	h. 6½	50 pcs.	750 pcs.
POZ90-1369	Lock System 200 Kit	-	-	500 pcs.	10,000 pcs
POZ95-1321	Pipe Connection - Grey	ø 110	ø 4⅓	100 pcs.	2,000 pcs.
POZ90-1361H	Heavy Grating	200 x 27 x 500	8 x 1 x 19¾	100 pcs.	2,000 pcs.
POZ90-1366H	End Cap Heavy	h. 175	h. 6⅞	152 pcs.	1,368 pcs.

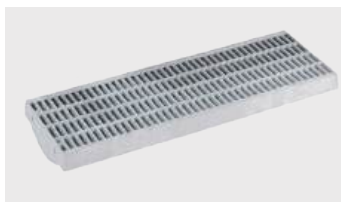

HEAVY GRATING
POZ90-1361H



END CAP
POZ90-1366H



END CAP
POZ90-1366

Pegasus Multi-Packs

Pegasus Short 130 (5") Kit - 12m (39.4ft)

Kit composed of 24 PP channels, dimensions 130 x 75 x 500mm (5 x 3 x 19³/₄" in grey, 5 end caps and 24 PP gratings (500mm - 19³/₄"). Sold as complete boxes only.

Materials - Made of PP (polypropylene).

Use - Used for the collection and drainage of rainwater, particularly in the connection between ramps and garage entrances and/or for sub-surface rooms.



Code	Product	Size mm	Size in.	Pack size	Pallet
POZ91-1300KI	24 Pegasus Short Channels - 130/75 Grey, 24 Strong gratings, 5 End Caps. 12m (39.4ft).	130 x 75 x 500	5 x 3 x 19 ³ / ₄	24 pcs.	8 boxes

Pegasus 130/75 (5" x 3") Display Kits - 3m (10ft)

Kits comprise 3 PP channels dimensions 130 x 75 x 1,000mm (5 x 3 x 39³/₈" in gray or black. Supplied complete with 1 set of end caps and a choice of PP or galvanised gratings. Packed in a retail display carton. Sold as complete kits only.

Materials - Channels made of PP (polypropylene), gratings made of PP or galvanised steel.

Use - Used for the collection and drainage of rainwater, particularly in the connection between ramps and garage entrances and/or for sub-surface rooms.



Code	Product	Size mm	Size in.	Pack size	Pallet
POZ91-1301KC3	3 Pegasus Plus Channels - 130/75 Grey, 3 Extra Strong Gray PP gratings with clip, 1 End Cap Set. 3 meter (10 ft)	130 x 75 x 1,000	5 x 3 x 39 ³ / ₈	3 pcs.	20 boxes
POZ91-1301KZ	3 Pegasus Plus Channels - 130/75 Grey, 3 Galvanised gratings with clip, 1 End Cap Set. 3 meter (10 ft)	130 x 75 x 1,000	5 x 3 x 39 ³ / ₈	3 pcs.	20 boxes
POZ91-1301KNC3	3 Pegasus Plus Channels - 130/75 Black, 3 Extra Strong Gray PP gratings with clip, 1 End Cap Set. 3 meter (10 ft)	130 x 75 x 1,000	5 x 3 x 39 ³ / ₈	3 pcs.	20 boxes
POZ91-1301KNZ	3 Pegasus Plus Channels - 130/75 Black, 3 Galvanised gratings with clip, 1 End Cap Set. 3 meter (10 ft)	130 x 75 x 1,000	5 x 3 x 39 ³ / ₈	3 pcs.	20 boxes

Pegasus Multi-Packs

Pegasus 130/75 (5" x 3") Bundle Kits - 3m (10ft)

Kits comprise 3 PP channels dimensions 130 x 75 x 1,000mm (5 x 3 x 39³/₈") in grey or black. Supplied complete with 1 set of end caps and a choice of PP or galvanised gratings. Shrink-wrapped in bundles. Sold as complete kits only.

Materials - Channels made of PP (polypropylene), gratings made of PP or galvanised steel.

Use - Used for the collection and drainage of rainwater, particularly in the connection between ramps and garage entrances and/or for sub-surface rooms.



Code	Product	Size mm	Size in.	Pack size	Pallet
POZ91-1301KC3	3 Pegasus Plus Channels - 130/75 Grey, 3 Extra Strong Gray PP gratings with clip, 1 End Cap Set. 3 meter (10 ft).	130 x 75 x 1,000	5 x 3 x 39 ³ / ₈	3 pcs.	20 packs
POZ91-1301KZ	3 Pegasus Plus Channels - 130/75 Grey, 3 Galvanised gratings with clip, 1 End Cap Set. 3 meter (10 ft).	130 x 75 x 1,000	5 x 3 x 39 ³ / ₈	3 pcs.	20 packs
POZ91-1301KNC3	3 Pegasus Plus Channels - 130/75 Black, 3 Extra Strong Gray PP gratings with clip, 1 End Cap Set. 3 meter (10 ft).	130 x 75 x 1,000	5 x 3 x 39 ³ / ₈	3 pcs.	20 packs
POZ91-1301KNZ	3 Pegasus Plus Channels - 130/75 Black, 3 Galvanised gratings with clip, 1 End Cap Set. 3 meter (10 ft).	130 x 75 x 1,000	5 x 3 x 39 ³ / ₈	3 pcs.	20 packs

Pegasus 130/120 (5" x 4³/₄") Bundle Kits - 3m (10ft)

Kits comprise 3 PP channels dimensions 130 x 120 x 1,000mm (5 x 4³/₄ x 39³/₈") in grey or black. Supplied complete with 1 set of end caps and a choice of PP or galvanized gratings. Shrink-wrapped in bundles. Sold as complete kits only.

Materials - Channels made of PP (polypropylene), gratings made of PP or Galvanized steel.

Use - Used for the collection and drainage of rainwater, particularly in the connection between ramps and garage entrances and/or for sub-surface rooms.



Code	Product	Size mm	Size in.	Pack size	Pallet
POZ91-1303KC3	3 Pegasus Plus Channels - 130/120 Grey, 3 Extra Strong Gray PP gratings with clip, 1 End Cap Set. 3 meter (10 ft).	130 x 120 x 1,000	5 x 4 ³ / ₄ x 39 ³ / ₈	3 pcs.	20 packs
POZ91-1303KZ	3 Pegasus Plus Channels - 130/120 Grey, 3 Galvanised gratings with clip, 1 End Cap Set. 3 meter (10 ft).	130 x 120 x 1,000	5 x 4 ³ / ₄ x 39 ³ / ₈	3 pcs.	20 packs
POZ91-1303KNC3	3 Pegasus Plus Channels - 130/120 Black, 3 Extra Strong Gray PP gratings with clip, 1 End Cap Set. 3 meter (10 ft).	130 x 120 x 1,000	5 x 4 ³ / ₄ x 39 ³ / ₈	3 pcs.	20 packs
POZ91-1303KNZ	3 Pegasus Plus Channels - 130/120 Black, 3 Galvanised gratings with clip, 1 End Cap Set. 3 meter (10 ft).	130 x 120 x 1,000	5 x 4 ³ / ₄ x 39 ³ / ₈	3 pcs.	20 packs

Catch Basins

Dakota Catch Basins and their accessories are widely used in place of traditional concrete installations due to their low weight, easy handling and overall strength and performance capabilities.

The catch basins are made from polypropylene and are available in a range of sizes, from 200mm to 700mm (8 to 28") square, to suit any application. Siphoned traps are also available on many of the products to prevent drain odors.

The catch basins can be stacked, to create vertical extensions, in cases where very deep excavations are encountered, and allow fast and precise connection for piping of all sizes.

The range of accessories (covers, gratings, extenders, frames, odour traps, etc.) expand the usage potential and enable compatibility with concrete catch pits.

Catch basins, also known as catchpits or stormwater basins, serve several important purposes in drainage systems:

Sediment and Debris Removal

Catchpits act as interception points for stormwater, allowing the removal of sediment and debris before it enters the main drainage system. This prevents clogging and extends the life of the overall drainage infrastructure.

Water Quality Improvement

By capturing pollutants and contaminants in stormwater runoff, catchpits contribute to improving water quality. This is especially important in urban areas where runoff can carry pollutants from roads and other surfaces into water bodies.

Preventing Flooding

Catchpits play a crucial role in preventing local flooding by efficiently collecting and channeling excess water during heavy rainfall. This helps in reducing the risk of water accumulation on streets and other public spaces.

Preventing Odour Escape

Well designed, modern, plastic catchpits will have provision for the installation of siphonic water traps to ensure that foul-smelling gases produced in the sewer system are trapped below the water level in the bend of the trap. This prevents these gases, which can carry unpleasant odours, from rising up through the drain and contaminating the neighbouring environment.

Erosion Control

The proper management of stormwater through catchpits helps control erosion by preventing excessive runoff that can wash away soil and contribute to soil degradation.



Smart Catch Basins

The "Smart" range of catch basins (inspection chambers), are available in various sizes from 200mm - 550mm (8" - 21") square in grey.

Main characteristics:

- Light weight for easy transport, positioning and installation, even by a single person
- High resistance thanks to the rounded side reinforcements that help prevent breakages at the corners
- Pipes of many sizes can easily be fitted thanks to the special pre-cut concentric shapes for the side holes

- Storage space reduced by half, thanks to the hi-stacking (nesting) design
- Compatible with a range of matched sizes of PP inspection chamber covers and gratings
- Slot in plates available to create siphonic system for odour control

Made of PP (polypropylene).

Use: Used as an alternative to traditional concrete catch basins for rain and storm water collection. Also suitable for housing sub-surface electrical devices/cables.

Code	Product	Size mm (W x D x L)	Size in. (W x D x L)	Pack size	Pallet
POZ01-1372I	Smart Catchpit	200 x 200	8 x 8	1 pc.	288 pcs.
POZ01-1372IS	Smart Export Catchpit	200 x 200	8 x 8	1 pc.	288 pcs.
POZ01-1373I	Smart Catchpit	300 x 300	12 x 12	1 pc.	112 pcs.
POZ01-1373IS	Smart Export Catchpit	300 x 300	12 x 12	1 pc.	112 pcs.
POZ01-1374I	Smart Catchpit	400 x 400	16 x 16	1 pc.	45 pcs.
POZ01-1374IS	Smart Export Catchpit	400 x 400	16 x 16	1 pc.	45 pcs.
POZ01-1378K	Smart Catchpit	550 x 550	21¾ x 21¾	1 pc.	24 pcs.

For inlet and outlet diameters, please refer to our website - www.dakota.co.uk



Plus Catch Basins

plastic catch basins for drainage systems

The "Plus" drainage inspection chambers, also known as a catch basins or catch pits, are available in various sizes, from 200mm - 550mm (8" - 21½") square in grey and green.

Main characteristics:

- Light weight for easy transport, positioning and installation, even by a single person
- High resistance thanks to the reinforcements and ribs at the sides

- Pipes of many sizes can easily be fitted thanks to the special pre-cut concentric shapes for the side holes
- Compatible with a range of matched sizes of PP inspection chamber covers and gratings
- Slot-in plates available to create siphonic trap for odor control

Made of PP (polypropylene).

Use: Used as an alternative to traditional concrete catch basins for rain and storm water collection.

Code	Product	Size mm (W x D x L)	Size in. (W x D x L)	Pack size	Pallet
POZ01-1372	Catchpit Plus	200 x 200	8 x 8	1 pc.	150 pcs.
POZ01-1372S	Export Catchpit Plus	200 x 200	8 x 8	1 pc.	240 pcs.
POZ01-1372V	Green Catchpit Plus	200 x 200	8 x 8	1 pc.	150 pcs.
POZ01-1372B	Catchpit Plus	250 x 250	10 x 10	1 pc.	160 pcs.
POZ01-1372BV	Green Catchpit Plus	250 x 250	10 x 10	1 pc.	160 pcs.
POZ01-1373	Catchpit Plus	300 x 300	12 x 12	1 pc.	48 pcs.
POZ01-1373S	Export Catchpit Plus	300 x 300	12 x 12	1 pc.	96 pcs.
POZ01-1373V	Green Catchpit Plus	300 x 300	12 x 12	1 pc.	48 pcs.
POZ01-1374	Catchpit Plus	400 x 400	16 x 16	1 pc.	18 pcs.
POZ01-1374S	Export Catchpit Plus	400 x 400	16 x 16	1 pc.	36 pcs.
POZ01-1374	Green Catchpit Plus	400 x 400	16 x 16	1 pc.	27 pcs.
POZ01-1371	Catchpit Plus	550 x 550	21¾ x 21¾	1 pc.	20 pcs.



Standard Catch Basins

The "Standard" drainage inspection chambers, also known as catch basins or catch pits, are available in 200mm and 300mm (8" and 12") square in grey.

Main characteristics:

- Light weight for easy transport, positioning and installation, even by a single person
- High resistance thanks to the reinforcements and ribs at the sides
- Pipes of many sizes can easily be fitted thanks to the special pre-cut concentric shapes for the side holes

- Compatible with a range of matched sizes of PP inspection chamber covers and gratings
- Pre-cut pipe inlets: POZ01-1372E - 63, 85 and 100mm (2½, 3⅓ and 4")
- POZ01-1373E - 85, 100, 130 and 145mm (3⅓, 4, 5 and 5¾")

Made of PP (polypropylene).

Use: Used as an alternative to traditional concrete catch basins for rain and storm water collection.

Code	Product	Size in. (W x D x L)	Size in. (W x D x L)	Pack size	Pallet
POZ01-1372E	Catchpit Standard Grey	200 x 200	8 x 8	1 pc.	180 pcs.
POZ01-1373E	Catchpit Standard Grey	300 x 300	12 x 12	1 pc.	48 pcs.

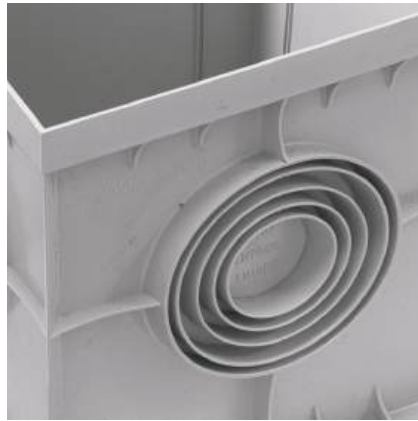

Seventy Catch Basins

extra large 'Seventy' catch pit

Extra Large catchpit, dimensions: 735mm x 735mm x 650mm (28" x 28" x 25½").

Main characteristics:

- Light weight for easy transport, positioning and installation, less than 25kgs / 55lbs
- High resistance thanks to the reinforcements and ribs at the sides
- Pipes of many sizes can easily be fitted thanks to the special pre-cut concentric shapes for the side holes
- Space at top corners for connecting 1" to 2" pipes
- Pre-cut on the bottom for removal for stacking for height extension - can also be cut horizontally every 10cm (4")
- Compatible with a cast iron manhole cover, or with the special 'Seventy' covers
- The internal dimensions are 600mm (24") square (mansize)
- Pre-cut pipe inlets: 200, 250, 315, 400 and 500mm (8, 10, 12, 16 and 20")

Made of PP (polypropylene).



Use: Used as a valid alternative to traditional concrete wells and particularly suitable for housing hydraulic and/or electrical devices for earthed systems. The Seventy manhole is the largest on the market and, unlike traditional concrete manholes, it is produced with a removable bottom and can be lifted by a person rather than by a crane!

Code	Product	Size mm (W x D x L)	Size in. (W x D x L)	Pack size	Pallet
POZ01-1370	Gray 'Seventy' Catchpit	700 x 700	27½ x 27½	1 pc.	8 pcs.
POZ02-7070M	Gray Cover with Double Handle for 'Seventy' Catchpit	700 x 700	27½ x 27½	1 pc.	24 pcs.
POZ02-7070MV	Green Cover with Double Handle for 'Seventy' Catchpit	700 x 700	27½ x 27½	1 pc.	24 pcs.
POZ04-7070T	Gray Frame for 'Seventy' Catchpit	700 x 700	27½ x 27½	1 pc.	19 pcs.
POZ04-7070TV	Green Frame for 'Seventy' Catchpit	700 x 700	27½ x 27½	1 pc.	19 pcs.

Cover & Frame for 'Seventy' Catchpit

The cover is a PP reinforced “plate” with 5 fiber-reinforced beams, laterally interlocked on the underside. The external surface is fitted with inserts of non-slip rubber and a pair of ergonomic retractable handles.

Capacity: 35 KN (approx. 3.500 kgs / 7,700 lbs).

Cover made of PP (polypropylene), fiber-reinforced nylon and rubber. Frame made of PP (polypropylene).

Use: Used to cover the Catchpit, allowing inspection and providing an excellent alternative to traditional concrete catchpit covers.

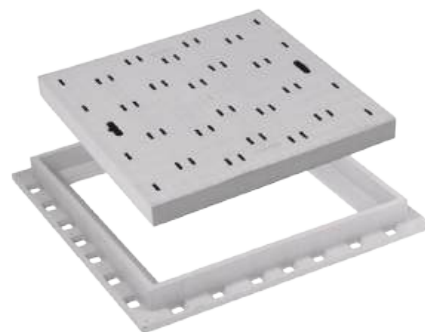

Rainwater Gullies

"Pluvial" gully stormwater catch basin

The "pluvial" gully pot is designed for the collection of storm water from gutter downpipes and its disposal into drainage systems.

A bulkhead (provided with each catch basin) enables a perfect siphon effect, preventing the return of bad odours. The bulkhead can be easily removed for inspection and/or cleaning.

Main characteristics:

- Light weight and easy to install
- High resistance thanks to the reinforcements and ribs at the sides
- Adaptor accessories available for both round and square down pipes. Sizes: round 80mm - 100 mm (3½" - 4") and 90mm - 110mm (3½" - 4½"), square 80mm - 100 mm (3½" - 4")
- Supplied with siphon bulkhead - prevents bad odors
- Sealed design prevents contamination and clogging with debris and leaves.

Made of PP (polypropylene).

Use: Collection and dispersal of storm water.



Code	Product	Size mm (W x D x L)	Size in. (W x D x L)	Pack size	Pallet
TER06-1385	"Pluvial" Catchpit Grey with 80/100 inlet	235 x 125 x 220	9¼ x 5 x 8⅔	18 pcs.	216 pcs.
TER06-1385SN	"Pluvial" Catchpit Black with 80/100 inlet	235 x 125 x 220	9¼ x 5 x 8⅔	18 pcs.	216 pcs.
TER06-1385S	"Pluvial" Export Catchpit Grey with 90/110 inlet	235 x 125 x 220	9¼ x 5 x 8⅔	18 pcs.	216 pcs.

accessories

Code	Product	Size mm (W x D x L)	Size in. (W x D x L)	Pack size	Pallet
TER06-1390	Round Inlet Junction	80 - 100	3⅓ - 4	50 pcs.	-
TER06-1390S	Export Round Inlet Junction	90 - 110	3½ - 4½	50 pcs.	-
TER06-1392	Round Outlet adaptor to 110mm (4⅓")	110	4⅓	84 pcs.	-
TER06-1391	Square Junction	80 - 100	3⅓ - 4	50 pcs.	-
TER06-1385C	Cover for "Pluvial" Catchpic	125 - 125	5 - 5	600 pcs.	-

Rainwater Gullies / Catch Pits / Sumps

"Eco-Pluvial" gully

The eco-pluvial sump is a device used to collect water from the eaves/downpipes and to drain it.

It has several components:

- a tilting anti-backflow barrier, preventing the return of bad odors
- a removable basket for collecting debris
- pilasters to provide support
- a cover with different sizes, 80mm - 125mm (3½" - 5") for the inlet pipe
- photo-etched "open-closed" cover (customisable)
- an outlet fitting for a drain pipe with a diameter of 80mm/100mm/110mm (3½" - 4")
- a limit stop to control the water flow

Made of PP (polypropylene).

Use: Collection and dispersal of storm water.



Code	Product	Size mm (W x D x L)	Size in. (W x D x L)	Pack size	Pallet
TER06-1386	"Eco-Pluvial" Catchpit Grey	235 x 125 x 220	9¼ x 5 x 8⅔	18 pcs.	90 pcs.
TER06-1386N	"Eco-Pluvial" Catchpit Black	235 x 125 x 220	9¼ x 5 x 8⅔	18 pcs.	90 pcs.
TER06-1386M	"Eco-Pluvial" Catchpit Brown	235 x 125 x 220	9¼ x 5 x 8⅔	18 pcs.	90 pcs.



Hermetic Chambers for Electrical use

"Airtight" versions of Dakota drainage inspection chambers, also known as catch basins or catch pits, are provided with a hermetic seal and pre-cut outlet points on the bottom, with the possibility of mounting press tube fittings.

Many of the different size Dakota Catch Basins can be made waterproof with the use of a special seal and cover, thus providing a wide choice for installations of underground electrical cabling and junctions.

The advantages of hermetically sealed catchpits, including water resistance and corrosion prevention, make them essential for the installation of sub-surface electrical services. Their use enhances the reliability, safety, and longevity of electrical infrastructure in both urban and industrial settings, as well as providing easy access for maintenance purposes.



Code	Product	Size mm (W x D x L)	Size in. (W x D x L)	Pack size	Pallet
POZ10-1347	Hermetic Catchpit for Electrical Installations	250 x 250	10 x 10	1 pc.	96 pcs.

Hermetic "Airtight" Chamber

This 250mm - 250mm (10" - 10") airtight catch basin with allows easy placement of components for junctions in cables, ensuring adequate protection and air tightness, due to the provided rubber gasket and screws for fastening down the lid. It has pre-cut outlet points on the bottom and can be drilled to accept all standard waterproof electrical sealing glands.

Made of PP (polypropylene).

Used for the grounding of electric cables, allowing the easy placement of the components of the junctions and cables and providing adequate protection against water ingress. This product is ideal in conjunction with poles for public lighting, or for routing and connection of telephone and IT cabling services.

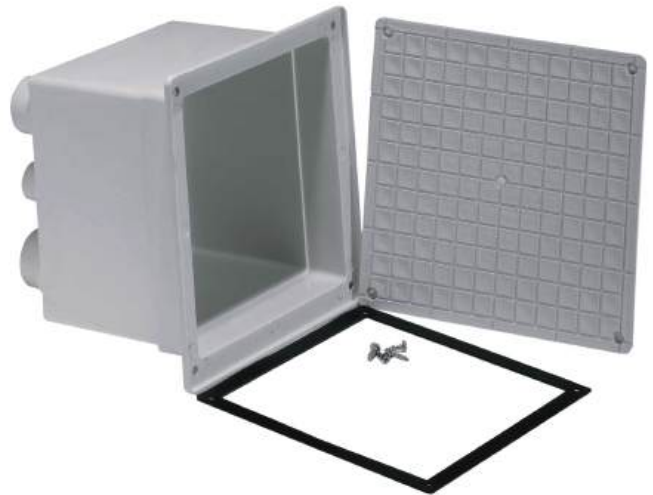

Hermetic Catch Basin Covers & Gaskets

Airtight covers and waterproofing gaskets to fit Dakota Catch Basins to make them suitable for housing electrical components and junctions.

Made of PP (polypropylene).

Used to create a waterproof enclosure for sub-surface electrical cables and components.

Code	Product	Size mm (W x D x L)	Size in. (W x D x L)	Pack size	Pallet
POZ02-1348K	Hermetic Cover	200 x 200	8 x 8	1 pc.	1,080 pcs.
POZ02-1400	Gasket and screws	200 x 200	8 x 8	1 pc.	500 pcs.
POZ02-1358K	Hermetic Cover	300 x 300	12 x 12	1 pc.	480 pcs.
POZ02-1406	Gasket and screws	300 x 300	12 x 12	1 pc.	400 pcs.
POZ02-1368K	Hermetic Cover	400 x 400	16 x 16	1 pc.	225 pcs.
POZ02-1407	Gasket and screws	400 x 400	16 x 16	1 pc.	500 pcs.
POZ01-1378K	Hermetic Cover	550 x 550	21¾ x 21¾	1 pc.	68 pcs.
POZ02-1408	Gasket and screws	550 x 550	21¾ x 21¾	1 pc.	500 pcs.



Catch Basin Accessories

Dakota offers a wide range of accessories, covers, gratings and frames to go along with the different sizes and types of catch basins.

Most catch basin are offered with options for creating siphon traps for odour control, as well as different choices of cover styles, etc. Our aim is to offer the

widest choice to customers to better meet exact requirements.

Dakota accessories allow customisation of the products to suit most requirements for functionality and appearance.

Siphon Plates for Standard & Plus Catch Basins

The siphon plate is placed inside the catchpit, using the location grooves. This creates a siphoning effect and water barrier to prevent drain odors. The plates are available in grey and in various sizes to fit 200mm, 300mm, 400mm and 550mm (8", 12", 16" and 21⁷/₁₀" square catch basins.

Made of PP (polypropylene).

Use: Used to allow the siphoning of the catch-pit, thanks to the easy application system.

Note: Not compatible with 'Smart' Catch Basins.

Code	Product	Pack size	Pallet
POZ06-1378	Siphon Plate 200mm (8")	300 pcs.	9,000 pcs.
POZ06-1379	Siphon Plate 300mm (12")	170 pcs.	2,040 pcs.
POZ06-1380	Siphon Plate 400mm (16")	60 pcs.	900 pcs.
POZ06-1389	Siphon Plate 550mm (21 ⁷ / ₁₀ "	20 pcs.	480 pcs.



Catch Basin Covers with Handle

Inspection chamber cover with a built-in, fold flush handle for easy lifting. The handle, in case of breakage or damage, can be replaced.

Available in 200mm, 300mm, 400mm and 550mm (8", 12", 16" and 21⁷/₁₀" square in grey or green.

Made of PP (polypropylene).

Use: As an inspection hatch to allow access to the catchpit.



Code	Product	Pack size	Pallet
POZ02-1348M Grey (-1348VM Green)	Cover with handle 200mm (8") sq.	1 pc.	1,080 pcs.
POZ02-1358M Grey (-1358VM Green)	Cover with handle 300mm (12") sq.	1 pc.	480 pcs.
POZ02-1368M Grey (-1368VM Green)	Cover with handle 400mm (16") sq.	1 pc.	150 pcs.
POZ02-1378M Grey (-1378VM Green)	Cover with handle 550mm (21.7") sq.	1 pc.	68 pcs.
POZ02-1368MM Grey (-1368VMM Green)	Handle with clip	1 pc.	-

Catch Basin Accessories

Catch Basin Covers with Siphon

Catch basin cover with a built-in, centrally position, siphoned inlet grating which allows the collection and flow of water as well as preventing any emission of unpleasant drain odours.

Made of PP (polypropylene).

Available in 300mm, 400mm, 450mm and 550mm (12", 16", 18" and 21⁷/₁₆") square in grey or green..

Use: As an inspection hatch to allow access to the catchpit whilst also acting as an odor trap.

Code	Product	Pack size	Pallet
POZ09-1361S Grey	Cover with Siphon 300mm (12") sq.	1 pc.	240 pcs.
POZ09-1371S Grey	Cover with Siphon 400mm (16") sq.	1 pc.	126 pcs.
POZ09-1391S* Grey	Cover with Siphon 450mm (18") sq.	1 pc.	104 pcs.
POZ09-1381S* Grey	Cover with Siphon 550mm (21 ⁷ / ₁₆ ") sq.	1 ps.	68 pcs.

* special order only



Catch Basin Height Extenders

This accessory enables height extension of the various catch basins in steps of 100mm (4") or 130mm (5") (POZ05-1377B only).

Available in the sizes of 200, 300, 400 and 550mm in grey.

Made of PP (polypropylene).

Use: It is placed on the top of the catchpit, in order to increase the height. Very useful for installations in sloped surfaces and where additional depth may be required.

Code	Product	Pack size	Pallet
POZ05-1382	Catchpit Extension 200mm (8") square	1 pc.	240 pcs.
POZ05-1376	Catchpit Extension 300mm (12") square	1 pc.	120 pcs.
POZ05-1377	Catchpit Extension 400mm (16") square	1 pc.	60 pcs.
POZ05-1377B	Catchpit Extension 550mm (21 ⁷ / ₁₆ ") square	1 pc.	44 pcs.



Bell Siphon for Catch Basins

The bell siphon is an accessory applicable to all our catchpits. Available for models 300mm and 400mm (12" and 16") square in grey.

Made of PP (polypropylene).

Use: It is used to create a "siphon effect" inside the catchpits. It is very easy to apply and to inspect. It is designed and structured to prevent the emission of bad odors and drain smells due to the stagnation of water. Perfectly matched with grating catchpit covers.

Code	Product	Pack size	Pallet
POZ07-6821N	Bell Siphon Plate 300mm (12")	1 pc.	112 pcs.
POZ076-6822N	Bell Siphon 400mm (16")	1 pc.	54 pcs.



Catch Basin Accessories

Cover 'Plus' for Catch Basins

Basic inspection chamber cover.

Available in 200mm, 250mm, 300mm, 350mm, 400mm, 450mm and 550mm (8", 10", 12", 14", 16", 18" and 21⁷/₁₆" square in grey or green.

Made of PP (polypropylene).



Code	Product	Pack size	Pallet
POZ02-1348 Grey (-1348V Green)	Catchpit Cover - 200mm (8") sq.	1 pc.	1,080 pcs.
POZ02-1328 Grey (-1328V Green)	Catchpit Cover - 250mm (10") sq.	1 pc.	660 pcs.
POZ02-1358 Grey (-1358V Green)	Catchpit Cover - 300mm (12") sq.	1 pc.	448 pcs.
POZ02-1338 Grey (-1338V Green)	Catchpit Cover - 350mm (14") sq.	1 pc.	300 pcs.
POZ02-1368 Grey (-1368V Green)	Catchpit Cover - 400mm (16") sq.	1 pc.	198 pcs.
POZ02-1388 Grey (-13868V Green)	Catchpit Cover - 450mm (18") sq.	1 pc.	88 pcs.
POZ02-1378A Grey (-1378V Green)	Catchpit Cover - 550mm (21 ⁷ / ₁₆ ") sq.	1 pc.	68 pcs.

Standard Covers

Catchpit cover with a moulded grip on the top surface to enable easy lifting.

Available in 200mm, 300mm and 400mm (8", 12" and 16") square in grey.

Made of PP (polypropylene).



Code	Product	Pack size	Pallet
POZ02-1348E Grey	Standard Cover 200mm (8") sq.	1 pc.	1,500 pcs.
POZ02-1358E Grey	Standard Cover 300mm (12") sq.	1 pc.	800 pcs.
POZ02-1368E Grey	Standard Cover 400mm (16") sq.	1 pc.	360 pcs.
POZ02-1368EN Grey	Standard Cover 400mm (16") sq. for 'Smart' Catchpit	1 pc.	360 pcs.

Dakota also manufactures a wide range of Manhole Frames, Covers & Gratings in Cast Iron, Stainless Steel, Galvanised Steel and Plastics to suit most applications - please enquire for details.

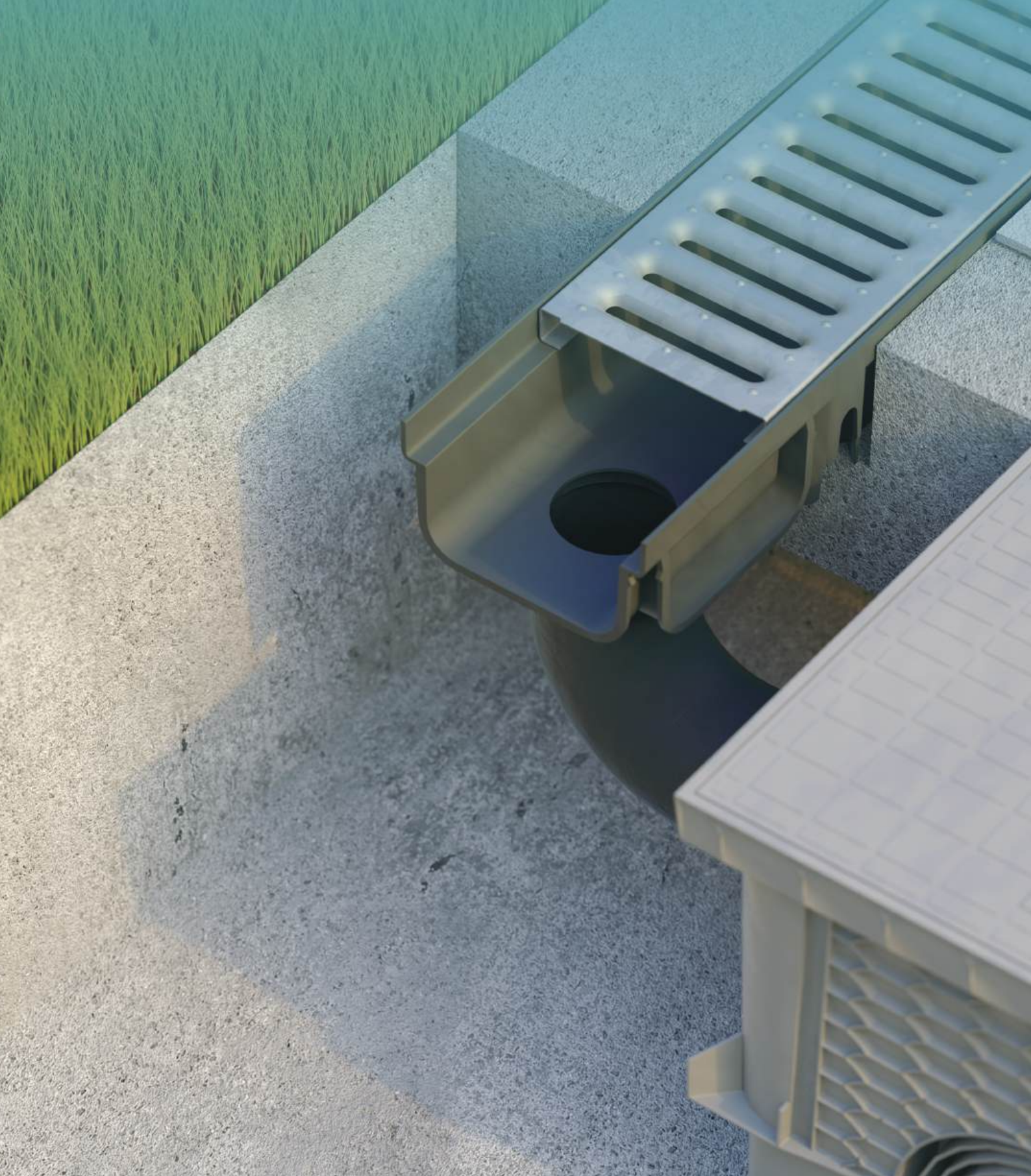

DAKOTA

United Kingdom

Unit B, Wainstalls Business Park, Wainstalls, Halifax, West Yorkshire, HX2 7UR
+44 (0)1422 872273 sales@dakota.co.uk www.dakota.co.uk