

DAKOTA  
United Kingdom



Outdoor Products



## Innovative Building Solutions

PRODUCTION AND DISTRIBUTION OF CONSTRUCTION PRODUCTS

Six divisions, more than four thousand innovative products dedicated to construction, fast deliveries, and more than 40 years of experience. High quality Italian designed and manufactured products for indoor and outdoor applications including drainage, flooring, landscaping and more.

## Investing In Innovation Since 1980

It was only in 1980 when our first plastic injection machines were brought into operation for the moulding of construction products. Today, over forty years later, with more than 140 state-of-the-art moulding machines, the Dakota Group remains committed to developing and supplying innovative products for the construction industry. We consistently expand our product range and innovate on our production technologies - making our products increasingly advanced, higher performing, and occasionally unique.

***Innovate to evolve. The only way forward.***



## External Floor and Deck Support Systems

In landscaping and for outdoor architecture, the choice of mounting and levelling systems for external floors and decks now plays a crucial role in ensuring both functionality and aesthetics. While conventional construction methods have been the norm for years, the emergence of pedestal support systems has revolutionised the way we approach outdoor flooring. Let's look at the benefits that make pedestal support systems a superior choice over traditional methods.

### Versatility and Adaptability

Pedestal support systems offer unparalleled versatility, allowing for the installation of external floors and decks on a variety of surfaces. Whether you're dealing with uneven terrain or irregular surfaces, these systems can easily adapt to the environment, providing a level and stable foundation. This flexibility opens up design possibilities, enabling architects and homeowners to create stunning outdoor spaces in locations that were once considered challenging.

### Easy Installation and Maintenance

One of the standout advantages of pedestal support systems is their ease of installation. Traditional construction methods for levelling the ground often involve complex earth moving processes and heavy machinery. In contrast, pedestals can be quickly and easily adjusted to the required heights, simplifying the entire installation process. Moreover, maintenance becomes a breeze as access to utilities beneath the flooring is straightforward, making repairs or modifications simple and cost-effective.

### Enhanced Drainage and Ventilation

Pedestal support systems promote optimal drainage and ventilation, preventing water accumulation and moisture-related issues. Conventional methods may struggle with proper water runoff, leading to potential damage to the structure over time. The open design of pedestal systems allows for efficient water drainage, reducing the risk of mould, rot, and other water-related issues, thus ensuring the longevity of the outdoor flooring.

### Environmentally Friendly

In an era where sustainability is paramount, pedestal support systems shine as an eco-friendly alternative. Recycled materials are used in the making of these systems and they are suitable for recycling again at end of life. Additionally, their installation requires fewer resources compared to traditional construction methods. This not only minimises the environmental impact but also aligns with the growing trend of green and sustainable building practices.

### Cost-Effective Solutions

One of the prime advantages of pedestal systems is the cost saving potential from eliminating much of the labour typically required by traditional construction methods. While initial material costs might seem comparable between traditional and pedestal-supported construction, the labour and long-term savings become evident. The simplified installation process and reduced maintenance requirements contribute to overall cost-effectiveness. Additionally, the adaptability of pedestal systems means that they can easily be reused in different or extended projects, further optimising the investment.

In the ever-evolving landscape of outdoor architecture, pedestal supported systems have emerged as a game-changer. Their versatility, ease of installation, environmental friendliness, and cost-effectiveness make them a superior choice for mounting and levelling external floors and decks. As we continue to prioritise functionality, aesthetics and sustainability, pedestal support systems stand tall as the ideal solution to elevate outdoor spaces to new heights.

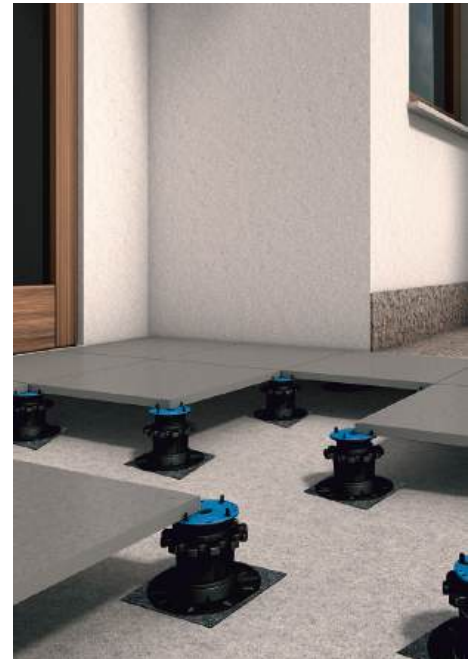

ARMIMEDE™ RANGE OF PEDESTALS



HERCULES RANGE OF PEDESTALS

# ARMIMEDE™ 10

extra low profile - 10mm to 20mm ( $\frac{3}{8}$ " to  $\frac{3}{4}$ " )



Adjustable from 10mm to 15mm ( $\frac{3}{8}$ " to  $\frac{9}{16}$ " ) as standard, or 15mm to 20mm ( $\frac{9}{16}$ " to  $\frac{3}{4}$ " ) using the 5mm ( $\frac{1}{8}$ " ) height extender plate supplied with each pedestal.

Base laying surface: 191cm<sup>2</sup> (29 $\frac{2}{3}$ sq.in).

Head diameter: 156mm (6").

The base includes water drainage channels.

Made of recycled PP (polypropylene).

Available versions:

- paver support with 4 spacer tabs of 2mm ( $\frac{5}{64}$ " ) thickness.
- paver support with 4 spacer tabs of 4mm ( $\frac{5}{32}$ " ) thickness.
- joist support with 1 tab for decking and flooring.

Used in external areas for terraces, pavements and decks. Internally for tiled and wood flooring.



Code	Product	mm	in.	Pack size	Pallet
TER09-1147/4A2M	ARMIMEDE™ 10 - Paving Spacer tabs 2mm ( $\frac{5}{64}$ " )	10 - 20	$\frac{3}{8}$ - $\frac{9}{16}$	30 pcs.	810 pcs.
TER09-1147/4A4M	ARMIMEDE™ 10 - Paving Spacer tabs 4mm ( $\frac{5}{32}$ " )	10 - 20	$\frac{3}{8}$ - $\frac{9}{16}$	30 pcs.	810 pcs.
TER09-1147/1A	ARMIMEDE™ 10 - Decking	10 - 20	$\frac{3}{8}$ - $\frac{9}{16}$	-	810 pcs.
TER09-1147/C	Anti-noise rubber shim thick 1mm ( $\frac{1}{25}$ " )	-	-	120 pcs.	15,120 pcs.

*\*Average value of maximum capacity on several tests ' load distributed on the head ! 1KN = 101.97 kg (225 lbs.). Inch measurements are to nearest common fraction.*



# ARMIMEDE™ 18

low profile - 18mm to 36mm ( $\frac{3}{4}$ " to  $1\frac{1}{16}$ " )



Each pedestal comprises a base plate, extender ring, threaded adjustment collar and support head. Adjustable from 18mm to 27mm ( $\frac{3}{4}$ " to  $1\frac{1}{16}$ " ) as standard, or 27mm to 36mm ( $1\frac{1}{16}$ " to  $1\frac{1}{16}$ " ) with the 9mm ( $\frac{3}{8}$ " ) extender ring supplied pre-assembled with each pedestal.

Base laying surface: 314cm<sup>2</sup> (49sq.in).

Head diameter: 120mm (4 $\frac{3}{4}$ " ).

The base includes water drainage channels.

Made of recycled PP (polypropylene).

Available versions:

- paver support with 4 spacer tabs of 2mm ( $\frac{5}{64}$ " ) thickness.
- paver support with 4 spacer tabs of 4mm ( $\frac{5}{32}$ " ) thickness.
- joist support with 1 tab for decking and flooring.

Used in external areas for roof gardens, terraces, pavements and decks. Internally for tiled and wood flooring.



Code	Product	mm	in.	Pack size	Pallet
TER09-1145/4A2M	ARMIMEDE™ 18 - Paving Spacer tabs 2mm ( $\frac{5}{64}$ " )	18 - 36	$\frac{3}{4}$ - $1\frac{1}{16}$	30 pcs.	1,350 pcs.
TER09-1145/4A4M	ARMIMEDE™ 18 - Paving Spacer tabs 4mm ( $\frac{5}{32}$ " )	18 - 36	$\frac{3}{4}$ - $1\frac{1}{16}$	30 pcs.	1,350 pcs.
TER09-1145/1A	ARMIMEDE™ 18 - Decking	18 - 36	$\frac{3}{4}$ - $1\frac{1}{16}$	30 pcs.	1,200 pcs.
TER09-1145/P9	ARMIMEDE™ - Extension h.9	9	$\frac{3}{8}$	30 pcs.	3,780 pcs.

*\*Average value of maximum capacity on several tests ' load distributed on the head ! 1KN = 101.97 kg (225 lbs.). Inch measurements are to nearest common fraction.*

# ARMIMEDE™ 35

standard profile - 35mm to 60mm (1<sup>3</sup>/<sub>8</sub>" to 2<sup>3</sup>/<sub>8</sub>" )



Each pedestal comprises a base plate, threaded adjustment collar and support head. Adjustable from 35mm to 60mm (1<sup>3</sup>/<sub>8</sub>" - 2<sup>3</sup>/<sub>8</sub>" ) as standard. Clip in extenders in 25mm, 50mm, 100mm (1", 2", 4") available.

Base laying surface: 314cm<sup>2</sup> (49sq.in).  
Head diameter: 120mm (4<sup>3</sup>/<sub>4</sub>" ).

The base includes water drainage channels.

Made of recycled PP (polypropylene).

Available versions:

- paver support with 4 spacer tabs of 2mm (5/64") thickness.
- paver support with 4 spacer tabs of 4mm (5/32") thickness.
- joist support with 1 tab for decking and flooring.

Used in external areas for roof gardens, terraces, pavements and decks.



Code	Product	mm	in.	Pack size	Pallet
TER09-1143/4A2M	ARMIMEDE™ 35 - Paving Spacer tabs 2mm (5/64")	35 - 60	1 <sup>3</sup> / <sub>8</sub> - 2 <sup>3</sup> / <sub>8</sub>	30 pcs.	1,350 pcs.
TER09-1143/4A4M	ARMIMEDE™ 35 - Paving Spacer tabs 4mm (5/32")	35 - 60	1 <sup>3</sup> / <sub>8</sub> - 2 <sup>3</sup> / <sub>8</sub>	30 pcs.	1,350 pcs.
TER09-1143/1A	ARMIMEDE™ 35 - Decking	35 - 60	1 <sup>3</sup> / <sub>8</sub> - 2 <sup>3</sup> / <sub>8</sub>	30 pcs.	1,200 pcs.
TER09-1143/P25	ARMIMEDE™ - Extender h.25	25	1	30 pcs.	2,700 pcs.
TER09-1143/P50	ARMIMEDE™ - Extender h.50	50	2	30 pcs.	1,620 pcs.
TER09-1143/P100	ARMIMEDE™ - Extender h.100	100	4	30 pcs.	1,200 pcs.

*\*Average value of maximum capacity on several tests ' load distributed on the head ! 1KN = 101.97 kg (225 lbs.). Inch measurements are to nearest common fraction.*

# ARMIMEDE™ 41

self levelling - 41mm to 66mm (1<sup>5</sup>/<sub>8</sub>" to 2<sup>5</sup>/<sub>8</sub>" )



Each pedestal comprises a base plate, threaded adjustment collar and self-levelling support head. Adjustable from 41mm to 66mm (1<sup>5</sup>/<sub>8</sub>" - 2<sup>5</sup>/<sub>8</sub>" ) as standard. Clip in extenders in 25mm, 50mm, 100mm (1", 2", 4") available.

Base laying surface: 314cm<sup>2</sup> (49sq.in).  
Head diameter: 120mm (4<sup>3</sup>/<sub>4</sub>" ).

The base includes water drainage channels.

Made of recycled PP (polypropylene).

Available versions:

- paver support with 4 spacer tabs of 2mm (5/64") thickness.
- paver support with 4 spacer tabs of 4mm (5/32") thickness.
- joist support with 1 tab for decking and flooring.

Used in external areas for roof gardens, terraces, pavements and decks.



Code	Product	in.	mm	Pack size	Pallet
TER09-1193/4A2M	ARMIMEDE™ 41 - Paving Spacer tabs 2mm (5/64")	41 - 66	1 <sup>5</sup> / <sub>8</sub> - 2 <sup>5</sup> / <sub>8</sub>	30 pcs.	1,350 pcs.
TER09-1193/4A4M	ARMIMEDE™ 41 - Paving Spacer tabs 4mm (5/32")	41 - 66	1 <sup>5</sup> / <sub>8</sub> - 2 <sup>5</sup> / <sub>8</sub>	30 pcs.	1,350 pcs.
TER09-1193/1A	ARMIMEDE™ 41 - Decking	41 - 66	1 <sup>5</sup> / <sub>8</sub> - 2 <sup>5</sup> / <sub>8</sub>	30 pcs.	1,200 pcs.
TER09-1143/P25	ARMIMEDE™ - Extender h.25	25	1	30 pcs.	2,700 pcs.
TER09-1143/P50	Extension h.50	50	2	30 pcs.	1,620 pcs.
TER09-1143/P100	Extension h.100	100	4	30 pcs.	1,200 pcs.

*\*Average value of maximum capacity on several tests ' load distributed on the head ! 1KN = 101.97 kg (225 lbs.). Inch measurements are to nearest common fraction.*

# ARMIMEDE™ 60

higher profile - 60mm to 115mm (2<sup>3</sup>/<sub>8</sub>" to 4<sup>1</sup>/<sub>2</sub>" )



Each pedestal comprises a base stand, threaded adjustment collar and support head. Adjustable from 60mm to 115mm (2<sup>3</sup>/<sub>8</sub>" - 4<sup>1</sup>/<sub>2</sub>" ) as standard. Clip in extenders in 50mm, 100mm (2", 4") available.

Base laying surface: 314cm<sup>2</sup> (49sq.in).  
Head diameter: 120mm (4<sup>3</sup>/<sub>4</sub>" ).

The base includes water drainage channels.

Made of recycled PP (polypropylene).

Available versions:

- paver support with 4 spacer tabs of 2mm (5/64") thickness.
- paver support with 4 spacer tabs of 4mm (5/32") thickness.
- joist support with 1 tab for decking and flooring.

Used in external areas for roof gardens, terraces, pavements and decks.



Code	Product	mm	in.	Pack size	Pallet
TER09-1163/4A2M	ARMIMEDE™ 60 - Paving Spacer tabs 2mm (5/64")	60 - 115	2 <sup>3</sup> / <sub>8</sub> - 4 <sup>1</sup> / <sub>2</sub>	30 pcs.	450 pcs.
TER09-1163/4A4M	ARMIMEDE™ 60 - Paving Spacer tabs 4mm (5/32")	60 - 115	2 <sup>3</sup> / <sub>8</sub> - 4 <sup>1</sup> / <sub>2</sub>	30 pcs.	450 pcs.
TER09-1163/1A	ARMIMEDE™ 60 - Decking	60 - 115	2 <sup>3</sup> / <sub>8</sub> - 4 <sup>1</sup> / <sub>2</sub>	30 pcs.	450 pcs.
TER09-1143/P50	ARMIMEDE™ - Extender h.50	50	2	30 pcs.	1,620 pcs.
TER09-1143/P100	Extender h.100	100	4	30 pcs.	1,200 pcs.

\*Average value of maximum capacity on several tests ' load distributed on the head ! 1KN = 101.97 kg (225 lbs.). Inch measurements are to nearest common fraction.



# ARMIMEDE™ 115

extra high profile - 115mm to 220mm (4½" to 8⅔")



Each pedestal comprises a base stand, threaded adjustment collar and support head. Adjustable from 115mm - 220mm (4½" - 8⅔") as standard. Clip in extender in 100mm (4") available.

Base laying surface: 314cm<sup>2</sup> (49sq.in).

Head diameter: 120mm (4¾").

The base includes water drainage channels.

Made of recycled PP (polypropylene).

Available versions:

- paver support with 4 spacer tabs of 2mm (5/64") thickness.
- paver support with 4 spacer tabs of 4mm (5/32") thickness.
- joist support with 1 tab for decking and flooring.

Used in external areas for roof gardens, terraces, pavements and decks.

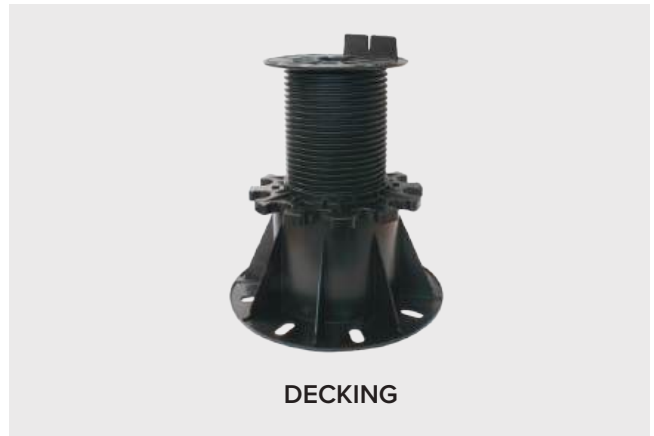

Code	Product	mm	in.	Pack size	Pallet
TER09-1173/4A2M	ARMIMEDE™ 115 - Paving Spacer tabs 2mm (5/64")	115 - 220	4½ to 8⅔	30 pcs.	225 pcs.
TER09-1173/4A4M	ARMIMEDE™ 115 - Paving Spacer tabs 4mm (5/32")	115 - 220	4½ to 8⅔	30 pcs.	225 pcs.
TER09-1173/1A	ARMIMEDE™ 115 - Decking	115 - 220	4½ to 8⅔	30 pcs.	225 pcs.
TER09-1143/P50	ARMIMEDE™ - Extender h.100	100	4	30 pcs.	1,200 pcs.

*\*Average value of maximum capacity on several tests ' load distributed on the head ! 1KN = 101.97 kg (225 lbs.). Inch measurements are to nearest common fraction.*

## Anti-noise accessories for ARMIMEDE™

Sound absorbing rubber mats and shims for the ARMIMEDE™ range of supports as well as for universal application with other products where suited.

**01 - 02** Acoustic, sound absorbing, rubber base pads for ARMIMEDE™ and other supports up to 20mm (8") in diameter. Thickness 3mm (1/8"). Made of recycled rubber (TPV). Used beneath the bases of pedestal supports as a cushioning layer to reduce footfall noise by up to 12dB. Also suitable for protective use when supports are being used on top of roofing or other membranes.

**03** Anti-noise rubber shims: moulded anti-noise rubber. Diameter 120mm (4¾"), thickness 2mm (5/64"). Made of thermoplastic rubber. This product is designed to be placed on the ARMIMEDE™ support heads for paving only. It provides acoustic damping and a cushioned base for pavers reducing walkover noise (not for ARMIMEDE™ 10).

**04** Anti-noise rubber shim for ARMIMEDE™ 10. This multi-purpose component provides acoustic damping and a cushioned base for both pavers and joists, providing a cushioned mounting surface and reducing walkover noise.



Code	Ref	Product	mm	in.	Pack size	Pallet
TER09-1144/P	01	Anti-noise rubber base pad	200 x 200 x 3	8 x 8 x 1/8	80 pcs.	9,600 pcs.
TER09-1144/T	02	Anti-noise rubber base pad	∅ 200 x 3	∅ 8 x 1/8	30 pcs.	10,800 pcs.
TER09-1143/G	03	Anti-noise rubber shim for paving	∅ 120 x 2	∅ 4¾ x 5/64	180 pcs.	16,200 pcs.
TER09-1147/G	04	Anti-noise rubber shim for ARMIMEDE™ 10	157 x 1	6¾/16 x 1/25	120 pcs.	15,120 pcs.

## Clever slope regulator

Levelling rubber discs for slope compensation. Diameter 120mm (4¾"), available in 1%, 3% and 5% slopes. Made of thermoplastic rubber. **Clever** allows the compensation of slopes from 1% - 5%. Can be used in combinations.

Just put them on the head of the support (with the arrow pointing in the direction of the slope) and twist for a final adjustment.

**Clever** guarantees the capability to have a perfectly flat surface and to reduce walkover noise.

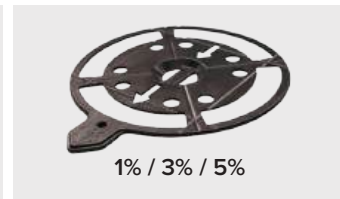
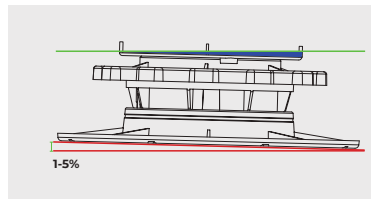
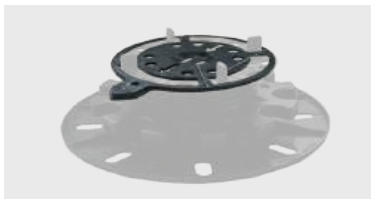

Code	Product	mm	in.	Bag	Pack size	Pallet
TER09-1143/C1	Clever for ARMIMEDE™ - slope 1%	∅ 120	∅ 4¾	30 pcs.	360 pcs.	32,400 pcs.
TER09-1143/C3	Clever for ARMIMEDE™ - slope 3%	∅ 120	∅ 4¾	30 pcs.	360 pcs.	32,400 pcs.
TER09-1143/C5	Clever for ARMIMEDE™ - slope 5%	∅ 120	∅ 4¾	30 pcs.	180 pcs.	16,200 pcs.

# Universal Joist Head

to convert ARMIMEDE™ paver supports

Universal decking head for ARMIMEDE™ supports.

It converts ARMIMEDE™ paver supports to enable supporting joists. Steel, aluminum or wood joists of any size up to a maximum width of 75mm (3") can be used. The pin can also be used to make "T" connections between joists.

The installation of the head increases the total height of the support by 11.5mm (7/16").

Made of recycled PP (polypropylene).

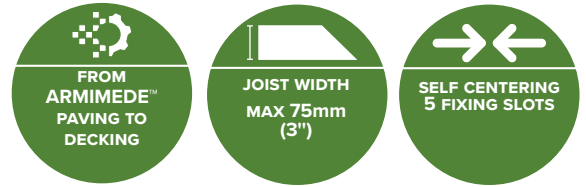

Code	Product	mm	in.	Pack size	Pallet
TER09-1142TPU	Universal joist head for ARMIMEDE™	ø 120	ø 4¾	30 pcs.	1,350 pcs.



## Side Mounting Plate Kit

for lateral finishing

- Suitable for use at sides and corners
- Adjustable for 8mm to 38mm (5/16" to 1 1/2") thick tiles/pavers
- Quick and easy to use and adjust
- Kit contains 10 x top plates, 30 slide in retainer clips and 10 base retainer adaptors.

The side finishing adaptor kit is designed for use with ARMIMEDE™ pedestal supports for tiles and pavers. It permits the vertical mounting of tiles to provide step risers or edges for raised patio installations. Each unit comprises one square top plate, which fits directly onto the top of pedestal, 3 slide-in side mount retainer clips and a base retainer adaptor that will clip

into the base plate of the pedestal. (Suitable for ARMIMEDE™ 35, 41, 60 & 115 paver pedestals only.)

Installation: Position the support pedestals so that the edge of the square top plate is inset from the edge of the pavers by the thickness of the side tile. Remove the tile spacer fins from the pedestal where these are not required. Fit the base retainer adaptor into the baseplate of the pedestal, positioning this so that the adaptor is projecting forwards. Place the pre-cut tile or paver side piece into position - slide one side retainer clip into the base retainer/s and slide the required number of side mount retainer clips into the square top plate slots to secure.

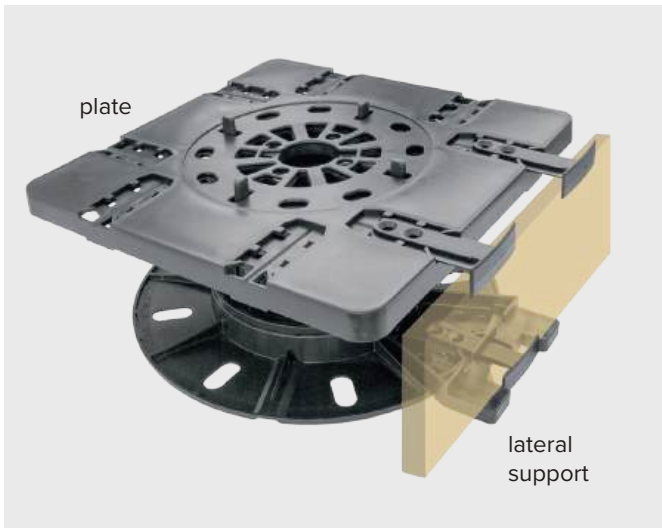

ARMIMEDE™ 35, 41, 60 AND 115  
(FOR PAVING ONLY)



ADJUSTABLE CLIPS  
FROM 8mm - 38mm (5/16" to 1 1/2")

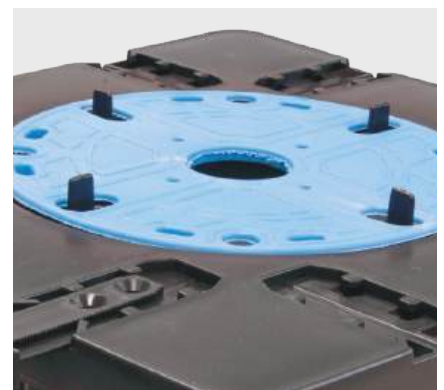

RUBBER SHIM  
ACCESSORY

Code	Product	mm	in.	Pack size	Pallet
TER09-1152/3BPL	Kit of 10 plates, 10 lateral supports and 30 tile fixing clips for lateral finishing	204 x 204	8 x 8	1 set	144 sets

## Stainless Steel Clips

for lateral finishing

**01** Set of clips, used in floating floor installations, for the finishing of the edges in the absence of a lateral wall.

Specifically designed to be used with ARMIMEDE™ 35, 41, 60 and 115 for paving only.

Made of stainless steel.

**02** Universal clip for the perimeter laying of tiles for floating floors. The clip is used to prevent contact between the tiles and adjacent walls. The special shape absorbs movements and normal expansion and contraction.

Compatible with ARMIMEDE™, Hercules and various other pedestals.

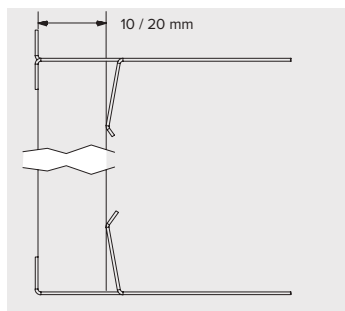
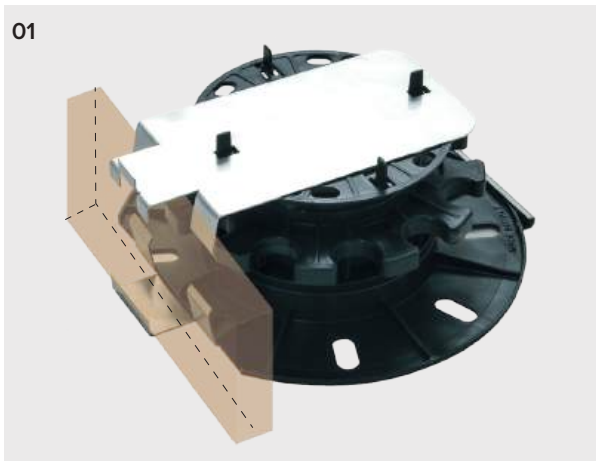

Code	Product	mm	in.	Pack size	Pallet
TER09-1146/C	Base clip for vertical finishing 10mm	10	3/8	100 pcs.	-
TER09-1146/E	Head clip for vertical finishing 10mm	10	3/8	100 pcs.	-
TER09-1146/D	Base clip for vertical finishing 20mm	20	13/16	100 pcs.	-
TER09-1146/F	Head clip for vertical finishing 20mm	20	13/16	100 pcs.	-
TER09-1146/A	Universal clip for lateral laying in stainless steel	-	-	100 pcs.	7,000 pcs.
TER09-1146/AP	Universal clip for lateral laying in PP	-	-	200 pcs.	7,000 pcs.

## Universal Clips

for lateral finishing

**01** Set of clips, used in floating floor installations, for the finishing of the edges in the absence of a lateral wall.

Specifically designed to be used with Hercules supports and Level Up. The different items can be used for ceramic tiles with thicknesses of 20mm, 30mm and 40mm ( $\frac{3}{8}$ ", 1" and  $\frac{1}{2}$ ").

Made of stainless steel.

**02** Universal clip for the perimeter laying of tiles for floating floors. The clip is used to prevent contact between the tiles and adjacent walls. The special shape absorbs movements and normal expansion and contraction.

Compatible with ARMIMEDE™, Hercules and Level Up

Available in stainless steel or PP (polypropylene).



Code	Product	mm	in.	Pack
TER09-1146/H20	Universal Head Clip for vertical finishing thick. 20	20	$\frac{3}{16}$	100 pcs.
TER09-1146/H30	Universal Head Clip for vertical finishing thick. 30	30	$1\frac{3}{16}$	100 pcs.
TER09-1146/H240	Universal Head Clip for vertical finishing thick. 40	40	$1\frac{9}{16}$	100 pcs.
TER09-1146/B20	Universal Base Clip for vertical finishing thick. 20	20	$\frac{3}{16}$	100 pcs.
TER09-1146/B30	Universal Base Clip for vertical finishing thick. 30	30	$1\frac{3}{16}$	100 pcs.
TER09-1146/B40	Universal Base Clip for vertical finishing thick. 40	40	$1\frac{9}{16}$	100 pcs.
TER09-1146/A	Universal Clip for lateral laying	-	-	100 pcs.
TER09-1146/AP	Universal Clip for lateral laying in PP	-	-	200 pcs.



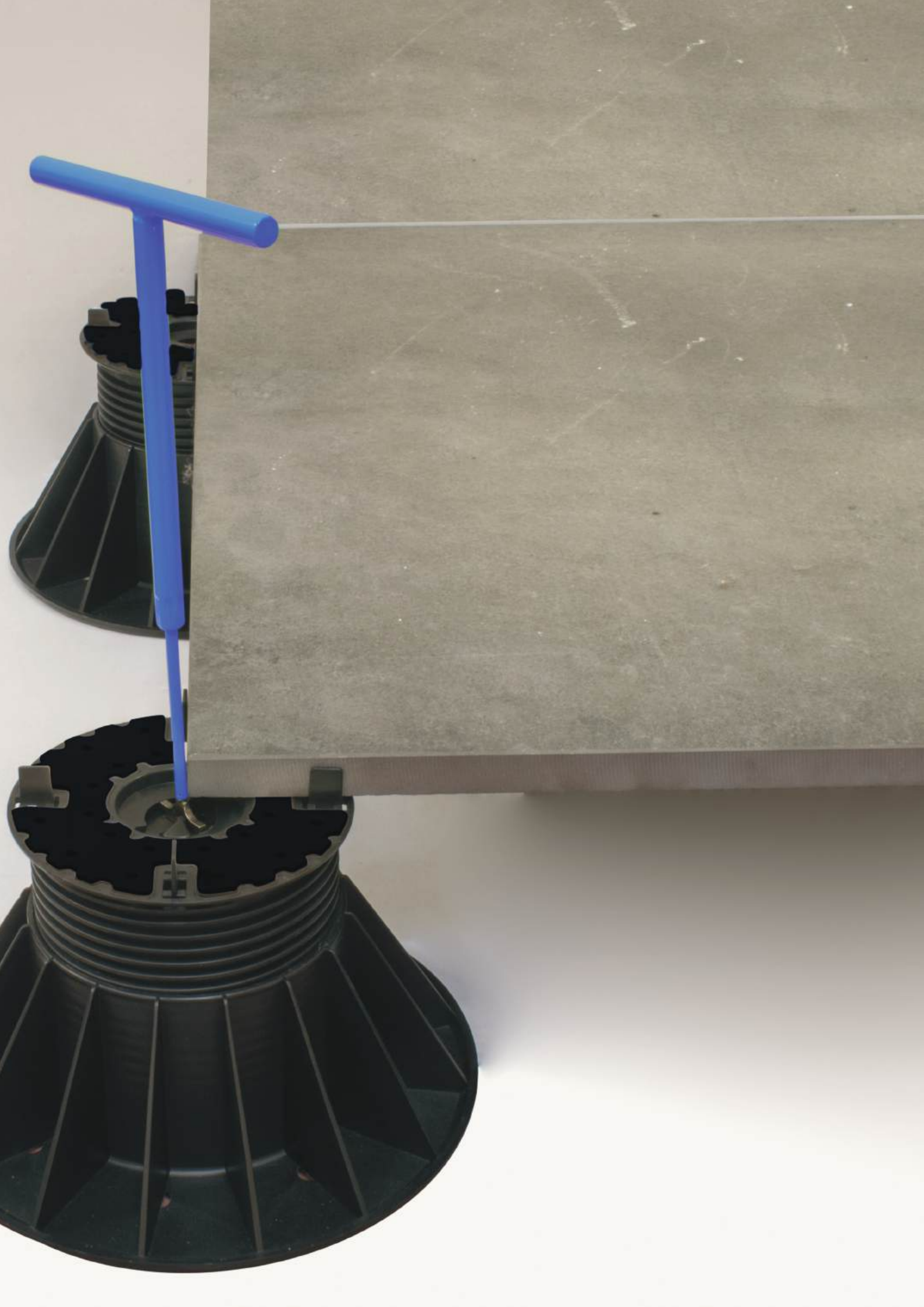

# Hercules

## professional pedestal support system

This 'top of the range' professional pedestal support system is designed for installations where high loads may be encountered, such as in public areas, and is also ideal for high-rise applications. The Hercules pedestals have large, load spreading, 210mm (8¼") or 230mm (9") diameter bases with heavy support ribs making them capable of supporting up to 3,000kgf (6,600lbf).

The very high load capability ensures these pedestals are suitable for use across a very wide range of leveling applications from patios, decks and roof gardens through to external buildings, log cabins, large hot tubs, surface pools and more. The pedestals are ideal for large decks with long joist spans (using 6" or 12" height joists), reducing the number of support points required.

A range of 5 pedestal bases offers adjustability starting from 25mm (1") height up to 270mm (10⅝") depending on the model used. The two largest pedestals can also be further extended to reach greater heights by addition of one or more screw-in extender sections - available separately. Each Extender can be adjusted to provide from 80mm to 140mm (3⅛" to 5½") of additional height.

The pedestals are adjustable either from below or, for paver installations, also from above using the special adjustment tool.

- Heavy Duty - up to 3,000kgf (6,600lbf) load capacity
- Versions for Pavers and for Decking Joists
- Fixed or Self-Levelling Heads
- Integrated Acoustic Rubber Layer on all Heads
- From 25mm to 270mm (1" to 10⅝") and extendable
- Adjustment from above for paver installations



**UP TO  
3000KG  
6600LB**



**FROM 25 MM  
TO OVER 1 M**

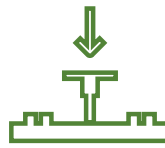

**ADJUSTABLE FROM THE  
TOP**

even with laid paving

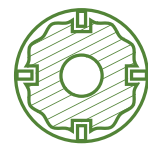

**RUBBER PAD  
INTEGRATED**

in the head  
(both paving and decking)



**25mm to 37mm  
1" to 1½"**



**37mm to 60mm  
1½" to 2⅜"**



**60mm to 94mm  
2⅜" to 3⅞"**



**94mm to 150mm  
3⅞" to 6"**



**150mm to 270mm  
6" to 10⅝"**

# Hercules 25

extra low profile - 25mm to 37mm (1" to 1½")



Hercules pedestal support for outdoor flooring, with adjustable height from 25mm to 37mm (1" to 1½")

Each pack contains the complete disassembled support with base, screw and fixed or self-levelling head (up to 5%) for paving with 4 removable tabs for 4mm (5/32") joints, or for joist support with a single securing fin.

The heads are equipped with integrated anti-noise rubber inlays.

The pedestal can be adjusted from below by rotating the base and head or, in the case of paver installations, the finalisation of the adjustment of the support takes place with the pavers installed using the special key.

Available versions:

- paver support with fixed head with 4 spacer tabs of 4mm (5/32") thickness
- joist support with fixed head with 1 tab for decking and flooring
- paver support with self-levelling head with 4 spacer tabs of 4mm (5/32") thickness
- joist support with self-levelling head with 1 tab for decking and flooring

Made of recycled PP (polypropylene).

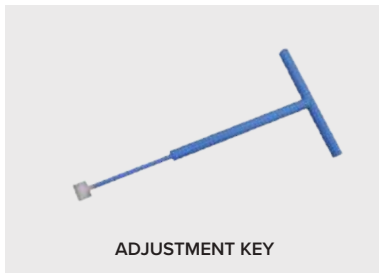

Code	Product	mm	in.	Pack size	Pallet
TER09-1183/4F25	Hercules Paving Fixed Head 4mm joint, 25mm - 37mm	25 - 37	1 - 1½	30 pcs.	720 pcs.
TER09-1183/1F25	Hercules Decking Fixed Head, 25mm - 37mm	25 - 37	1 - 1½	30 pcs.	720 pcs.
TER09-1183/4L25	Hercules Paving Self-Levelling Head 4mm joint	25 - 37	1 - 1½	30 pcs.	720 pcs.
TER09-1183/1L25	Hercules Decking Self-Levelling Head, 25mm - 37mm	25 - 37	1 - 1½	30 pcs.	720 pcs.
TER09-1183CHI	Adjustment key for Hercules	-	-	12 pcs.	-



# Hercules 37

low profile - 37mm to 60mm (1½" to 2¾")



Hercules pedestal support for outdoor flooring, with adjustable height from 37mm to 60mm (1½" to 2¾").

Each pack contains the complete disassembled support with base, screw and fixed or self-levelling head (up to 5%) for paving with 4 removable tabs for 4mm (5/32") joints, or for joist support with a single securing fin.

The heads are equipped with integrated anti-noise rubber inlays.

The pedestal can be adjusted from below by rotating the base and head or, in the case of paver installations, the finalisation of the adjustment of the support takes place with the pavers installed using the special key.

Available versions:

- paver support with fixed head with 4 spacer tabs of 4mm (5/32") thickness
- joist support with fixed head with 1 tab for decking and flooring
- paver support with self-levelling head with 4 spacer tabs of 4mm (5/32") thickness
- joist support with self-levelling head with 1 tab for decking and flooring

Made of recycled PP (polypropylene).



HERCULES 37 PAVING



HERCULES 37 DECKING

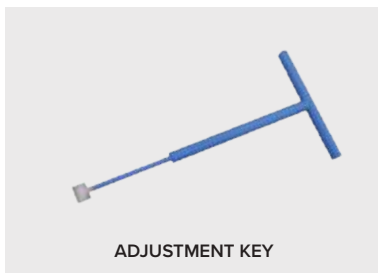

ADJUSTMENT KEY



0 - 5 %

Code	Product	mm	in.	Pack size	Pallet
TER09-1183/4F37	Hercules Paving Fixed Head 4mm joint, 37mm - 60mm	37 - 60	1½ - 2¾	30 pcs.	480 pcs.
TER09-1183/1F37	Hercules Decking Fixed Head, 37mm - 60mm	37 - 60	1½ - 2¾	30 pcs.	480 pcs.
TER09-1183/4L37	Hercules Paving Self-Levelling Head 4mm joint, 37mm - 60mm	37 - 60	1½ - 2¾	30 pcs.	480 pcs.
TER09-1183/1L37	Hercules Decking Self-Levelling Head, 37mm - 60mm	37 - 60	1½ - 2¾	30 pcs.	480 pcs.
TER09-1183CHI	Adjustment key for Hercules	-	-	12 pcs.	-

# Hercules 60

standard profile - 60mm to 94mm (2<sup>3</sup>/<sub>8</sub>" to 3<sup>11</sup>/<sub>16</sub>" )



Hercules pedestal support for outdoor flooring, with adjustable height from 60mm - 94mm (2<sup>3</sup>/<sub>8</sub>" to 3<sup>11</sup>/<sub>16</sub>").

Each pack contains the complete disassembled support with base, screw and fixed or self-levelling head (up to 5%) for paving with 4 removable tabs for 4mm (5/32") joints, or for joist support with a single securing fin.

The heads are equipped with integrated anti-noise rubber inlays.

The pedestal can be adjusted from below by rotating the base and head or, in the case of paver installations, the finalisation of the adjustment of the support takes place with the pavers installed using the special key.

Available versions:

- paver support with fixed head with 4 spacer tabs of 4mm (5/32") thickness
- joist support with fixed head with 1 tab for decking and flooring
- paver support with self-levelling head with 4 spacer tabs of 4mm (5/32") thickness.
- joist support with self-levelling head with 1 tab for decking and flooring

Made of recycled PP (polypropylene)



HERCULES 60 PAVING



HERCULES 60 DECKING

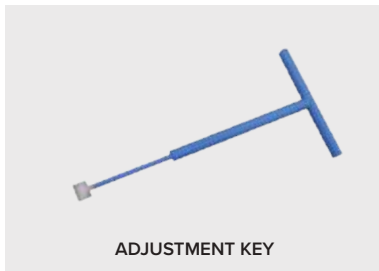

ADJUSTMENT KEY



0 - 5%

Code	Product	mm	in.	Pack size	Pallet
TER09-1183/4F60	Hercules Paving Fixed Head 4mm joint, 60mm - 94mm	60 - 94	2 <sup>3</sup> / <sub>8</sub> - 3 <sup>11</sup> / <sub>16</sub>	25 pcs.	300 pcs.
TER09-1183/1F60	Hercules Decking Fixed Head, 60mm - 94mm	60 - 94	2 <sup>3</sup> / <sub>8</sub> - 3 <sup>11</sup> / <sub>16</sub>	25 pcs.	300 pcs.
TER09-1183/4L60	Hercules Paving Self-Levelling Head 4mm joint, 60mm - 94mm	60 - 94	2 <sup>3</sup> / <sub>8</sub> - 3 <sup>11</sup> / <sub>16</sub>	25 pcs.	300 pcs.
TER09-1183/1L60	Hercules Decking Self-Levelling Head, 60mm - 94mm	60 - 94	2 <sup>3</sup> / <sub>8</sub> - 3 <sup>11</sup> / <sub>16</sub>	25 pcs.	300 pcs.
TER09-1183CHI	Adjustment key for Hercules	-	-	1 pc.	-

# Hercules 94

higher profile - 94mm to 150mm (3<sup>11</sup>/<sub>16</sub>" to 5<sup>7</sup>/<sub>8</sub>")



Hercules pedestal support for outdoor flooring, with adjustable height from 94mm to 150mm (3<sup>11</sup>/<sub>16</sub>" to 5<sup>7</sup>/<sub>8</sub>").

Each pack contains the complete disassembled support with base, screw and fixed or self-levelling head (up to 5%) for paving with 4 removable tabs for 4mm (5<sup>5</sup>/<sub>32</sub>" joints, or for joist support with a single securing fin.

The heads are equipped with integrated anti-noise rubber inlays.

The pedestal can be adjusted from below by rotating the base and head or, in the case of paver installations, the finalisation of the adjustment of the support takes place with the pavers installed using the special key.

This pedestal can be extended by using the 120mm (4<sup>3</sup>/<sub>4</sub>")

screw-in extension - TER09-1183/P120 - to achieve greater heights for installations.

Available versions:

- paver support with fixed head with 4 spacer tabs of 4mm (5<sup>5</sup>/<sub>32</sub>" thickness
- joist support with fixed head with 1 tab for decking and flooring
- paver support with self-levelling head with 4 spacer tabs of 4mm (5<sup>5</sup>/<sub>32</sub>" thickness
- joist support with self-levelling head with 1 tab for decking and flooring

Made of recycled PP (polypropylene).

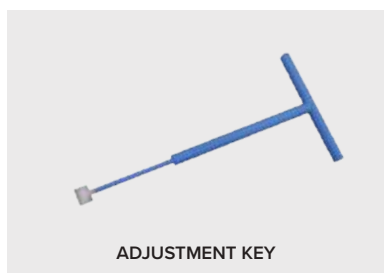

Code	Product	mm	in.	Pack size	Pallet
TER09-1183/4F94	Hercules Paving Fixed Head 4mm joint, 94mm - 150mm	94 - 150	3 <sup>11</sup> / <sub>16</sub> - 5 <sup>7</sup> / <sub>8</sub>	20 pcs.	160 pcs.
TER09-1183/1F94	Hercules Decking Fixed Head, 94mm - 150mm	94 - 150	3 <sup>11</sup> / <sub>16</sub> - 5 <sup>7</sup> / <sub>8</sub>	20 pcs.	160 pcs.
TER09-1183/4L94	Hercules Paving Self-Levelling Head 4mm joint, 94mm - 150mm	94 - 150	3 <sup>11</sup> / <sub>16</sub> - 5 <sup>7</sup> / <sub>8</sub>	20 pcs.	160 pcs.
TER09-1183/1L94	Hercules Decking Self-Levelling Head, 94mm - 150mm	94 - 150	3 <sup>11</sup> / <sub>16</sub> - 5 <sup>7</sup> / <sub>8</sub>	20 pcs.	160 pcs.
TER09-1183/P120	Extension h. 120mm for Hercules 94 and 150	-	-	20 pcs.	300 pcs.
TER09-1183CHI	Adjustment key for Hercules	-	-	1 pc.	-

# Hercules 150

extra high profile - 150mm to 270mm (5<sup>7</sup>/<sub>8</sub>" to 10<sup>5</sup>/<sub>8</sub>"



Hercules pedestal support for outdoor flooring, with adjustable height from 150mm to 270mm (5<sup>7</sup>/<sub>8</sub>" to 10<sup>5</sup>/<sub>8</sub>").

Each pack contains the complete disassembled support with base, screw and fixed or self-levelling head (up to 5%) for paving with 4 removable tabs for 4mm (5<sup>3</sup>/<sub>32</sub>" joints, or for joist support with a single securing fin.

The heads are equipped with integrated anti-noise rubber inlays.

The pedestal can be adjusted from below by rotating the base and head or, in the case of paver installations, the finalisation of the adjustment of the support takes place with the pavers installed using the special key.

This pedestal can be extended by using the 120mm (4<sup>3</sup>/<sub>4</sub>"

screw-in extension - TER09-1183/P120 - to achieve greater heights for installations.

Available versions:

- paver support with fixed head with 4 spacer tabs of 4mm (5<sup>3</sup>/<sub>32</sub>" thickness
- joist support with fixed head with 1 tab for decking and flooring
- paver support with self-levelling head with 4 spacer tabs of 4mm (5<sup>3</sup>/<sub>32</sub>" thickness
- joist support with self-levelling head with 1 tab for decking and flooring

Made of recycled PP (polypropylene).

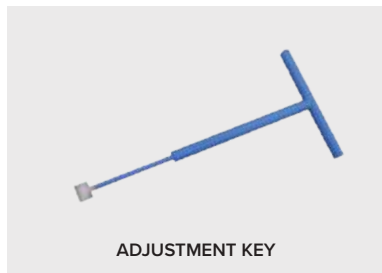

Code	Product	mm	in.	Pack size	Pallet
TER09-1183/4F150	Hercules Paving Fixed Head 4mm joint, 150mm - 270mm	150 - 270	5 <sup>7</sup> / <sub>8</sub> - 10 <sup>5</sup> / <sub>8</sub>	15 pcs.	120 pcs.
TER09-1183/1F150	Hercules Decking Fixed Head, 150mm - 270mm	150 - 270	5 <sup>7</sup> / <sub>8</sub> - 10 <sup>5</sup> / <sub>8</sub>	15 pcs.	120 pcs.
TER09-1183/4L150	Hercules Paving Self-Levelling Head 4mm joint, 150mm - 270mm	150 - 270	5 <sup>7</sup> / <sub>8</sub> - 10 <sup>5</sup> / <sub>8</sub>	15 pcs.	120 pcs.
TER09-1183/1L150	Hercules Decking Self-Levelling Head, 150mm - 270mm	150 - 270	5 <sup>7</sup> / <sub>8</sub> - 10 <sup>5</sup> / <sub>8</sub>	15 pcs.	120 pcs.
TER09-1183/P120	Extension h. 120mm for Hercules 94 and 150	-	-	20 pcs.	300 pcs.
TER09-1183CHI	Adjustment key for Hercules	-	-	1 pc.	-



PATENTED

## Level Up

the raised fall protection floor

Level Up is the ultimate solution for all types of raised external floor installations in public areas where safety and functionality are paramount considerations. It is very quick to install and it guarantees a safe and stable surface. Designed to meet high specification architectural requirements, Level-Up is 100% made in Italy by Dakota.

The Level-Up system is a patented design from Dakota that allows the creation of elevated, load-bearing structures. Level-Up is adjustable in height thanks to its pedestal style adjustable supports, with a minimum height 48mm (1 7/8") for the laying surface onto which pavers and tiles of any type, shape or size can be installed. The structure is made of a specific plastic compound material which is reinforced by galvanised steel profiles. Level up guarantees high safety standards and will prevent fall through in the event of any breakage or displacement of the floor covering materials.

Level-Up is easy to assemble, versatile and functional. It is a practical and safe solution for raised floors, enabling easy removal for inspection and/or for maintenance intervention. With this system, it is possible to change the floor surface tiling or covering, or elements beneath like pipes and cabling, at any time thus providing support for the evolution of spaces, without compromising their functionality.



## sizes and installation

90 x 90cm  
(36 x 36")

60 x 120cm  
(24 x 48")

60 x 60cm  
(24 x 24")

30 x 120cm  
(12 x 48")

40 x 120cm  
(16 x 48")

45 x 90cm  
(18 x 36")

Recommended installation for the sizes 90 x 90, 60 x 120, 60 x 60, 30 x 120, 40 x 120 and 45 x 90cm (36 x 36, 24 x 48, 24 x 24, 12 x 48, 16 x 48 and 18 x 36"). Use the central support in addition to the lateral ones.

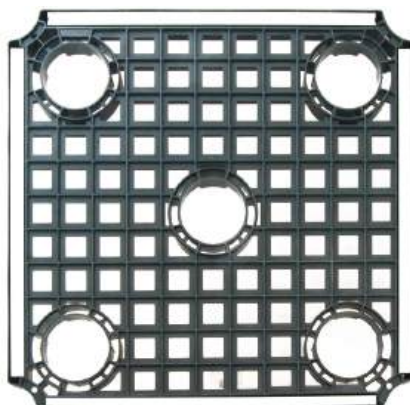

PATENTED

# Level Up components

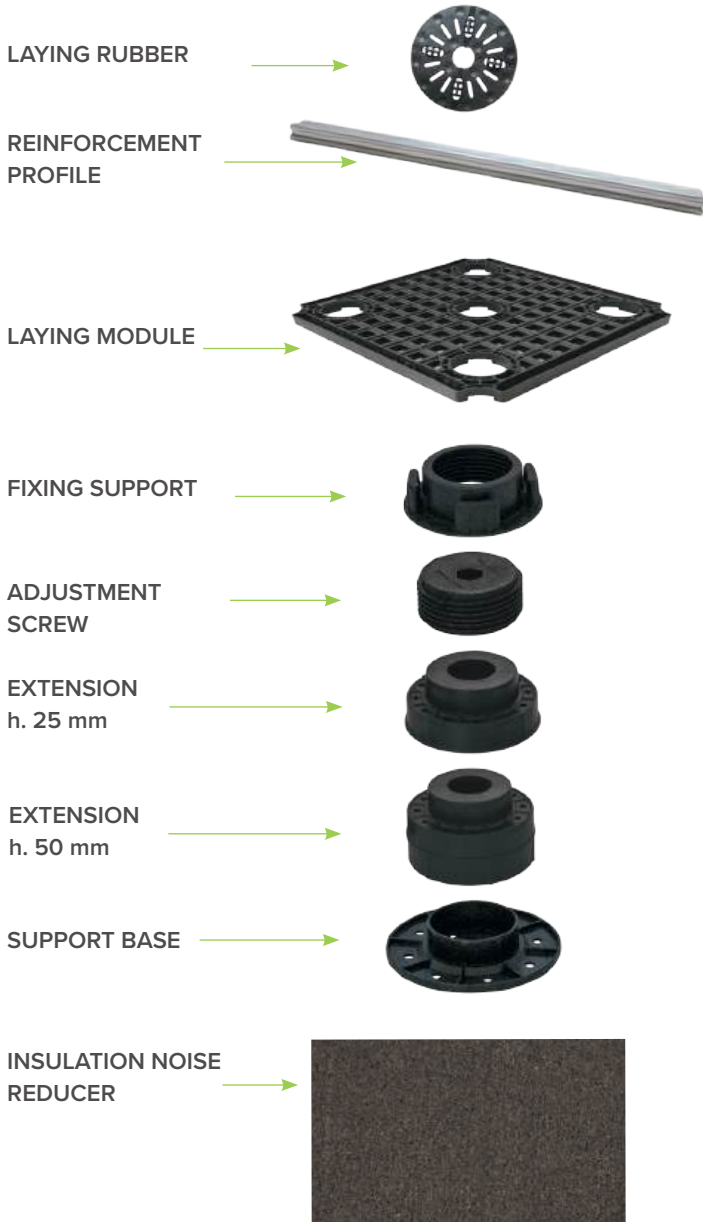

MINIMUM AND MAXIMUM HEIGHT WITHOUT EXTENSIONS

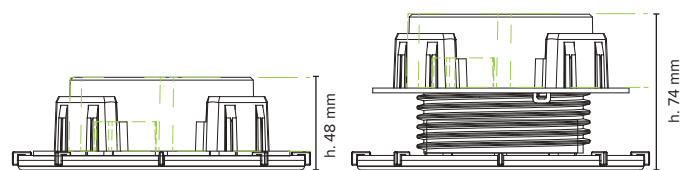

# Level Up

**PATENTED**

Level Up is the ultimate solution for your raised external floor. It is very quick to install and it guarantees a safe and stable surface onto which any type, shape or size of paver or tile, or wooden flooring, can be installed.

TER09-1124: Kit consists of 15 Laying Modules, 38 adjustable pedestal feet for Level-Up and 33 anti-noise rubber levelers (TER09-1131). The package allows for the installation of 5.4m<sup>2</sup> (58 sq.ft) of Level Up.

The kit, without the use of extensions, provides a height adjustment of the Level Up system from a minimum of 48mm (1<sup>7</sup>/<sub>8</sub>"") to a maximum of 74mm (2<sup>15</sup>/<sub>16</sub>"").

TER09-1129: Extension h.50mm (2") for Level-Up to be combined, if needed, with TER09-1124 kit.

TER09-1130: Extension h.25mm (1") for Level-Up to be combined, if needed, with TER09-1124 kit.

**Material** Level-Up is made of High Performance Plastic Material (HDPE) compound. The reinforcement profile is made of galvanised steel.

Pedestals and extensions are made of PP (polypropylene).

**Use** Level-Up is a Dakota patented system that allows the creation of a supporting structure, adjustable in height using its pedestal supports from minimum of 48mm (1<sup>7</sup>/<sub>8</sub>""), to create a laying surface for multi-format tiles, or other floor coverings, for outdoor use.

The Level-Up system guarantees high safety standards in case of breakage.

Supply method: Level Up is supplied in sets which provide for the coverage of minimum 5.4m<sup>2</sup> (58 sq.ft).

The parts that make up the basic set are:

- TER09-1125 Laying Module
- POZ95-1313 Reinforcement Profile - galvanised steel
- TER09-1124 Adjustable support

Extensions and insulation rubber mats are supplied as accessories.

Code	Product	mm	in.	Pack size	Pallet
TER09-1125	Laying Module	600 x 600 x h. 38	24 x 24 x h. 1 <sup>1</sup> / <sub>2</sub>	15 pcs.	60 pcs.
POZ95-1313	Reinforcement Profile	34 x 482 x h. 19	1 <sup>5</sup> / <sub>16</sub> x 19 x h. <sup>3</sup> / <sub>4</sub>	30 pcs.	2,820 pcs.
TER09-1124	38 pcs. adjustable support for Level Up + 33 pcs Laying Rubber (TER09-1131)	48 - 74	1 <sup>7</sup> / <sub>8</sub> x 1 <sup>15</sup> / <sub>16</sub>	1 pc.	15 boxes
TER09-1130	Extension h. 25	h. 25	h. 1	38 pcs.	2,128 pcs.
TER09-1129	Extension h. 50	h. 50	h. 2	38 pcs.	1,064 pcs.
TER09-1119	Hexagonal Adjustment pipe wrench for Level Up - hexagon size 20 mm	20	h. 1 <sup>13</sup> / <sub>16</sub> (approx.)	5 pcs.	-
TER09-1144	Insulation Noise Reducer	200 x 200 x 3	8 x 8 x <sup>1</sup> / <sub>8</sub>	80 pcs.	6,720 pcs.
TER09-1144/P	Insulation Noise Reducer Plus	200 x 200 x 3	8 x 8 x <sup>1</sup> / <sub>8</sub>	80 pcs.	9,600 pcs.
TER09-1144/T	Round Insulation Noise Reducer	ø 200 x 3	ø 8 x <sup>1</sup> / <sub>8</sub>	30 pcs.	10,800 pcs.

## Level Up - Lateral Finishing

**PATENTED**

Set of stainless steel clips that allow the finishing of the perimeter space, in the absence of a lateral wall, in installations of floating floors.

Specifically designed to be used with Dakota supports and Level Up. The different items can be used for ceramic tiles with thicknesses of 20mm, 30mm and 40mm (¾", 1" and 1½").

Universal clip for the perimeter laying of tiles for floating floors.

The clip prevents contact between the tiles and surrounding walls, thanks to its special shape that absorbs movements. Specifically designed to be used with Dakota Supports: ARMIMEDE™, Hercules and Level Up.

Available in stainless steel or PP (polypropylene).

**Use** Used for laying of perimeter tiles with Dakota raised floor supports.

Code	Product	mm	in.	Pack size	Pallet
TER09-1146/H20	Universal Head Clip for vertical finishing thick. 20	20	13/16	100 pcs.	-
TER09-1146/H30	Universal Head Clip for vertical finishing thick. 30	30	13/16	100 pcs.	-
TER09-1146/H40	Universal Head Clip for vertical finishing thick. 40	40	19/16	100 pcs.	-
TER09-1146/B20	Universal Head Clip for vertical finishing thick. 20	20	13/16	100 pcs.	-
TER09-1146/B30	Universal Head Clip for vertical finishing thick. 30	30	13/16	100 pcs.	-
TER09-1146/B40	Universal Head Clip for vertical finishing thick. 40	40	19/16	100 pcs.	-
TER09-1146/A	Universal clip for lateral laying	-	-	100 pcs.	-
TER09-1146/AP	Universal clip for lateral laying (in PP)	-	-	200 pcs.	-

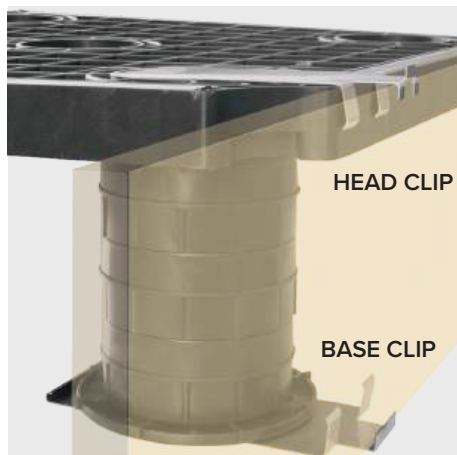



## Adjustable Joist Support

This clever adjustable support cradle provides a perfect solution where flooring or decking requires a minimal elevation height. Simple to install and adjust. The cradle can accept any joist up to a maximum width of 48mm (2" nominal). This product is a very popular and cost effective solution for the installation and levelling of roof-top decking and internal flooring.

Made of PP (polypropylene).

The support cradle comprises a threaded support with adjustment ring and a clip-in rubber base pad. A 20mm (¾") extender, which simply clips into the main support base in place of the rubber base pad, is available to increase the height range of the system. These can be used in multiples.

The support cradle is rated for an average maximum load of 365lbf (166 Kgf). Using a recommended minimum of 6 to 8 supports per square yard, this is equivalent to 243 to 324lbs/ft².

Use positioned on any firm surface as a base for the laying of joists during the installation of the under structure for floors or decking. For internal wood flooring it removes the need for levelling screeds and can be installed directly onto damp-proof membranes.

We suggest a minimum distribution of 6 to 8 supports per square yard, with joists spaced at 16" centres and supports positioned at 16" to 20" intervals along each joist. Where high loads are anticipated the weight bearing capacity can be increased by placing the supports closer together. When installing heavy, pre-built, joist frameworks, take care not to overload any single point of support during initial levelling. This can be avoided by using support wedges or jacks to reduce the weight until the required distribution of the supports is in place and adjusted.



Code	Ref	Product	mm	in.	Pack size	Pallet
TER09-1164	01	Adjustable joist support with rubber pad	14 - 50	½ - 2	30 pcs.	2,700 pcs.
TER09-1164/P20	02	Extension 20mm	20	¾	60 pcs.	6,480 pcs.

## Fix Tiles

**01** This budget, molded polypropylene, fixed height Paver Support 14mm ( $\frac{9}{16}$ " high with water channels in base and 4mm ( $\frac{5}{32}$ ") wide ribs allows perfect spacing of pavers or slabs. This product is weather-proof and suited for most types of pavers and slabs laid on pre-leveled grit or hard surfaces.

The base of the paver support has a smooth profile which minimises the possibility of damage when used on top of bituminous or other membranes. The base is designed to split into quadrants or halves for use at edges and corners.

**02/03** Spacer adjustment rings, in 1mm or 3mm ( $\frac{3}{64}$ " and  $\frac{1}{8}$ ") thicknesses are available to compensate for minor variations in the levels of the laying surface. The spacers can be stacked for larger adjustments and, like the tile support, are easily divided into halves or quadrants for use where differences in level are found between adjoining tiles.

**04** Anti-noise rubber, 1mm thick, can be inserted into the paver support and it is used to provide more friction between tile and stand and to decrease footfall noise.

Paver support and levelers made of PP (polypropylene),



Code	Ref	Product	mm	in.	Pack size	Pallet
TER09-1120	01	Fix tile support	-	-	360 pcs.	5,760 pcs.
TER09-1121/1	02	Leveller for tile	-	-	500 pcs.	10,000 pcs.
TER09-1121	03	Leveller for tile	-	-	500 pcs.	10,000 pcs.
TER09-1147/G	04	Anti-noise rubber shim for plates	-	-	120 pcs.	15,120 pcs.

## Outdoor Spacer for tiles

X shape tile spacer for outdoor. 100 pcs. per bag.  
This product is available in black polypropylene also.

Made of PPP (polypropylene).  
Used as a spacer in tiling.

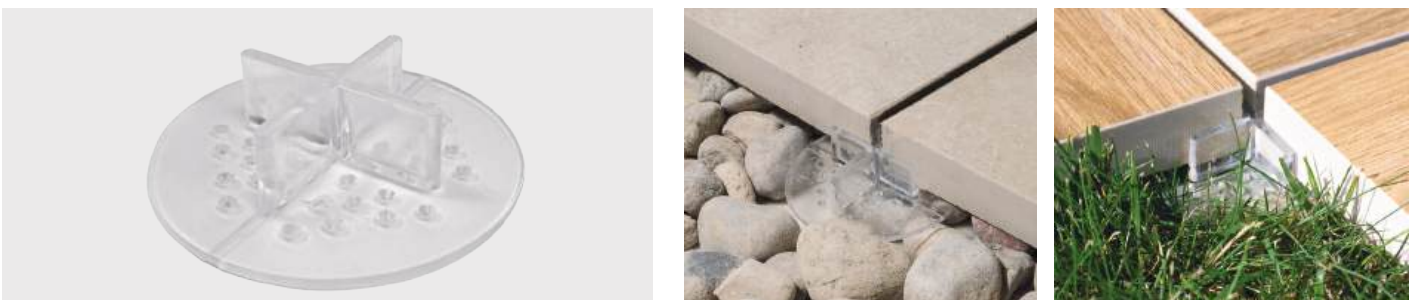

Code	Product	mm	in.	Pack size	Pallet
TER04-4300	Outdoor spacer for tiles 100 pcs.	thick. 4 - $\varnothing$ 64	thick. $\frac{5}{32}$ - $\varnothing$ 2 $\frac{1}{2}$	10 bags	200 bags
TER04-4300M	Outdoor spacer for tiles 200 pcs.	thick. 4 - $\varnothing$ 64	thick. - $\varnothing$ 2 $\frac{1}{2}$	200 bags	80 bags

# Quix System

## invisible fixing for decking

The Quix invisible mounting system for wooden decking boards, 115mm (4½") to 150mm (6") wide, offers a very flexible and practical method for securely fastening boards to a variety of joist based platforms. The system provides for very strong, stable installations, with space between the joists and deck boards to allow proper ventilation and extend the life of the materials used.

The system is easy to fit and is suitable for both DIY and professional use. Quix is supplied in a handy, reusable, plastic storage box with all the required components for around 4m<sup>2</sup> (43 sq. ft.) of decking. The components are also available for order separately for larger projects and for professional users.

The system enables the laying of the decking on either wood or metal joists and even directly onto concrete and, thanks to the 5mm (¾") deck board spacers, there will be a precise joint spacing for a uniform and professional final result.

### Advantages

- Invisible Fixing - completely hidden - no unsightly screw holes
- Permits replacement of damaged boards
- Ensures ventilation and extends life expectancy of wooden deck boards and joists
- High quality 100% recycled polypropylene components
- Temperature Range: -30°C to +60°C (-22°F to +140°F)
- Flexible and Strong - ensuring excellent hold down for deck boards
- Quick and Easy to Use
- Available in pre-packed kit, in a reusable polythene storage container

### Use

For the hidden fixing of wooden decking boards, 115mm (4½") to 150mm (6") wide, so that no screws are visible in the top surface. Recommended for domestic / pedestrian use.

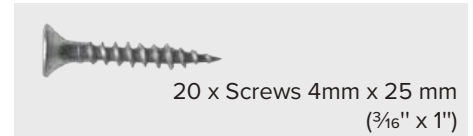
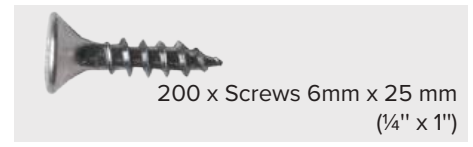
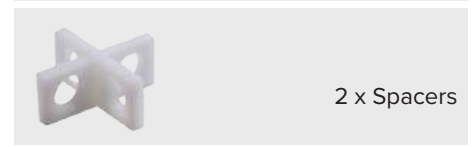

Code	Product	mm	in.	Pack size	Pallet
TER09-1147DK	Kit - 64 bars, 10 studs, 2 pcs. 5mm (¾") spacers and 2 sets of steel self-tapping screws (220 pcs. 6mm x 25mm (¼" x 1") and 20 pcs. 4mm x 25mm (¾" x 1"))	-	-	1 box	80 boxes

# Tak Level

## construction shims and wedges kit

Set of spacer shims and wedges (20 of each) for multiple applications in the construction industry. These are widely used during the installation of external raised decking. The combined use of 2 wedges guarantees precision adjustment of the joists and the use of the shims allows levelling of the surface over the under-structure of the decking itself.





In addition these wedges and shims can be used during the installation and fixing of doors and windows frames and for many other situations when a fast and modular levelling solution is required.

The 45 x 170 x 26mm (1¾ x 6¾ x 1") wedges, designed for larger gaps and increments, can be split into 2 smaller parts with dimensions 90 x 45 x 26/12mm (3½ x 1¾ x 1 - ½") and 74 x 4m x 11/1mm (3 x 1¾ x 7/16 - 1/16"). The smaller wedges can similarly be split into two parts.

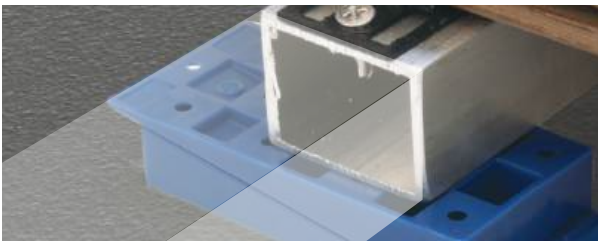
Each of the spacer shims can be split into 2 or 4 smaller pieces at the pre-cut lines and can then be interlocked and used in multiples or combinations to create whatever thickness is needed.

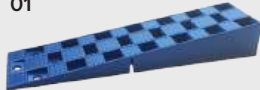
Made of PP (polypropylene).



01		45 x 170 x 26 mm 1¾ x 6¾ x 1"
02		45 x 90 x 15mm 1¾ x 3¾ x 9/16"
03		45 x 90 x 2mm 1¾ x 3¾ x 5/64"
04		45 x 90 x 3mm 1¾ x 3¾ x 5/8"
05		45 x 90 x 5mm 1¾ x 3¾ x 3/16"

Code	Product	mm	in.	Bag	Pack size	Pallet
TER09-1155	Tak Level Kit		-	-	1 box	80 boxes
TER09-2250	Wedges 90mm	45 x 90 x 15	1¾ x 3¾ x 9/16	40 pcs.	8 pcs.	45 boxes
TER09-2251	Wedges 170mm	45 x 170 x 15	1¾ x 6¾ x 9/16	40 pcs.	6 pcs.	36 boxes
TER09-2252	Shims 2mm	45 x 90 x 2	1¾ x 3¾ x 5/64	40 pcs.	28 pcs.	72 boxes
TER09-2253	Shims 3mm	45 x 90 x 3	1¾ x 3¾ x 5/8	40 pcs.	20 pcs.	72 boxes
TER09-2254	Shims 5mm	45 x 90 x 5	1¾ x 3¾ x 3/16	40 pcs.	20 pcs.	36 boxes



# Dak-Rock

## gravel stabilization grid

Dak-Rock is an HDPE or PP gravel and stabilisation geo-grid, resistant to frost. It guarantees a compact surface for both pedestrian and vehicular areas and provides perfect water drainage.

Thanks to its highly containing honeycomb structure for gravel and pebbles and to the layer of high-strength geotextile fabric, rainwater can be absorbed more evenly by the ground, ensuring uniform drainage management and a stable and safe surface for pedestrians and vehicles.

Materials - Dak-Rock structure is made of HDPE or PP and non-woven geotextile is made of PP.

Dak-Rock is used to stabilize gravel and pebbles for garden paths, pedestrian walkways, parking slots, terraces and various other areas for games, picnics, relaxation or recreational activities and staging.

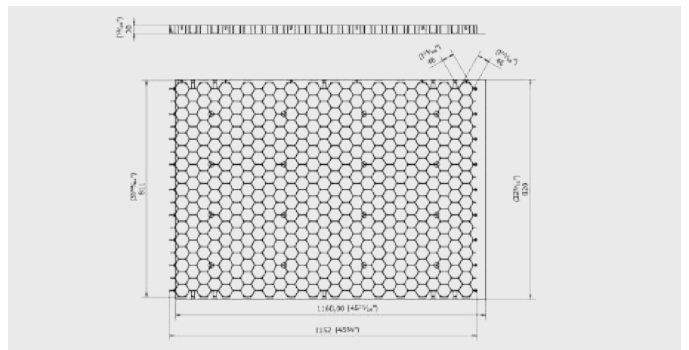

Load class test according to EN ISO 844:

- Test on empty structure = 140 T/m<sup>2</sup> (28,674 lbs sq.ft)
- Test on filled (gravel) structure = 400 T/m<sup>2</sup> (81,926 lbs sq.ft)

Code	Product	mm	in.	Pack size	Pallet
GAR01-0300	Dak-Rock - Gravel Stabilisation Grid	1,123 x 795 x 30	44 <sup>3</sup> / <sub>16</sub> x 31 <sup>5</sup> / <sub>16</sub> x 1 <sup>3</sup> / <sub>16</sub>	1 pc.	38 pcs.
GAR01-0300H	Dak-Rock - Gravel Stabilisation Grid	1,123 x 795 x 30	44 <sup>3</sup> / <sub>16</sub> x 31 <sup>5</sup> / <sub>16</sub> x 1 <sup>3</sup> / <sub>16</sub>	1 pc.	80 pcs.
GAR01-0300H2	Dak-Rock - Gravel Stabilisation Grid - Folded	1,123 x 1,590 x 30	44 <sup>3</sup> / <sub>16</sub> x 62 <sup>5</sup> / <sub>8</sub> x 1 <sup>3</sup> / <sub>16</sub>	1 pc.	19 pcs.
GAR01-0400	Dak-Rock - PP Gravel Stabilisation Grid	1,123 x 795 x 30	44 <sup>3</sup> / <sub>16</sub> x 31 <sup>5</sup> / <sub>16</sub> x 1 <sup>3</sup> / <sub>16</sub>	1 pc.	19 pcs.
GAR01-0400H	Dak-Rock - PP Gravel Stabilisation Grid	1,123 x 795 x 30	44 <sup>3</sup> / <sub>16</sub> x 31 <sup>5</sup> / <sub>16</sub> x 1 <sup>3</sup> / <sub>16</sub>	1 pc.	80 pcs.
GAR01-0400H2	Dak-Rock - PP Gravel Stabilisation Grid	1,123 x 795 x 30	44 <sup>3</sup> / <sub>16</sub> x 31 <sup>5</sup> / <sub>16</sub> x 1 <sup>3</sup> / <sub>16</sub>	1 pc.	80 pcs.

# Dak-Rock Heavy

## ground paving grid

Dak-Rock Heavy is a 500mm x 500mm x h.39mm (19<sup>2</sup>/<sub>16</sub>" x 19<sup>2</sup>/<sub>16</sub>" x h. 1<sup>1</sup>/<sub>2</sub>") ground reinforcement paving solution designed to improve natural water drainage and at the same time to prevent ground erosion. It is a perfect alternative to set bricks, flagstones, openwork paving slabs and different kinds of concrete based surfaces.

An innovative interlocking system enables the connection of the panels to create a continuous surface, which becomes

completely invisible once filled with aggregate or grass, preserving the natural character of the area.

Made of Polypropylene (PP).

It is used for the reinforcement and strengthening of grass layers destined for parking cars and/or recreational activities and/or staging.



The average values of the load class test according to EN ISO 844 are the following:

- Load at 3.8 mm (1/8"): 49.49 kN (11,125 lbf)
- Max Load: 49,81 kN (11,198 lbf)
- Deformation at max load: 3.50 mm (1/8")
- Stress: 76.97 N/mm<sup>2</sup> (11,163 lbs sq. in)
- Max load grid: 2,232 kN (501,773 lb/f)
- Load per sqm: 910 tonne ( 1,003 US tons)

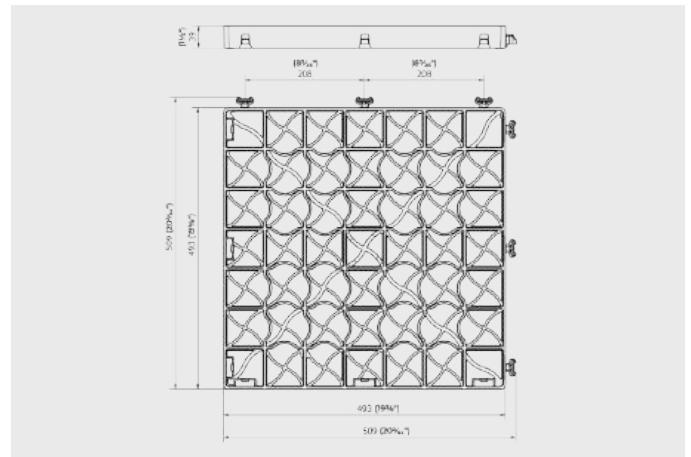

Code	Product	mm	in.	Pack size	Pallet
GAR01-0022N	Dak-Rock Heavy - Ground Paving Grid Black	500 x 500 x 39	19 <sup>1</sup> / <sub>16</sub> x 19 <sup>1</sup> / <sub>16</sub> x 1 <sup>1</sup> / <sub>16</sub>	1 pc.	288 pcs.
GAR01-0022GV	Dak-Rock Heavy - Ground Paving Grid Green	500 x 500 x 39	19 <sup>1</sup> / <sub>16</sub> x 19 <sup>1</sup> / <sub>16</sub> x 1 <sup>1</sup> / <sub>16</sub>	1 pc.	288 pcs.

# Green Plus

## grass grating - green

Green Plus is a green coloured grass grating tile for stabilising grassed areas to make them suitable for parking or other activities.

It consists of modular interlocking elements, available in 3 sizes.

Coloured caps that can be inserted into the cells are available for creating lines for defining roadways and parking spaces, or other areas.

Loading capacity > 300 tonnes/m<sup>2</sup> (30.72 US tons/sq.ft). Made of high density polyethylene (PE-HD).

It is used for the reinforcement of the grass in areas dedicated to parking spaces, recreational activities and staging.

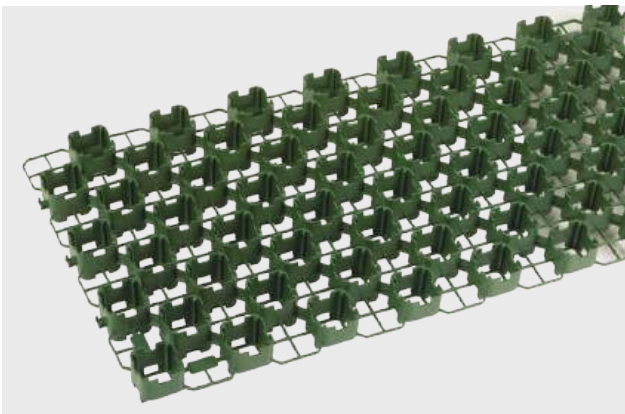

Code	Product	mm	in.	Pack size	Pallet
GAR01-0001/5	Green Plus	400 x 400 x 50	15¾ x 15¾ x 2	1 pc.	510 pcs.
GAR01-0002/4	Green Plus 2.4	400 x 800 x 40	15¾ x 31½ x 1⅙	1 pc.	156 pcs.
GAR01-0002/5	Green Plus 2.5	400 x 800 x 50	15¾ x 31½ x 2	1 pc.	132 pcs.
GAR01-0005	Yellow Cap	-	-	100 pcs.	-
GAR01-0006	White Cap	-	-	100 pcs.	-
GAR01-0007	Blue Cap	-	-	100 pcs.	-



# Georeef

for outdoor use

This product is for outdoor use that allows flexible curved shapes for creating divisions between different external areas. The profiles are very easy to install and will withstand most weather conditions and physical stresses.

The installation is quick and easy and it does not require any particular or special tools. The profiles can be connected to each other by overlapping the ends and, once positioned according to the layout, can be fixed to the ground using the provided plastic spikes.

GeoReef provides an excellent alternative to heavier and less aesthetically pleasing concrete edges.

Effective length of the package kit: 3m (118"), complete with 12 plastic spikes.

GeoReef is available in two different heights: 45mm (1¾") and 60mm (2⅜"), both in black. Made of PP (polypropylene).

Used to delineate areas of separation between different external areas. It is the ideal solution for defining the edges of flowerbeds, to isolate grassy areas from intrusive gravel, or to define protective areas around trees and bushes.



Code	Product	mm	in.	Pack size	Pallet
GAR03-0070	Georeef - landscape profile	3,000 x 45	118 x 1¾	1 pc.	21 pcs.
GAR03-0071	Georeef - landscape profile	3,000 x 60	118 x 2⅜	1 pc.	21 pcs.



**PATENTED**

## Draining Tiles

for outdoor & indoor use

Draining tiles have multiple areas of use in the garden and around the home for creating walk-on areas. They are also extensively used for indoor applications in commercial and industrial settings for creating defined areas in showrooms, for use around machines and workbenches in factories and for many other purposes.

The tiles are available in green, red and grey and are designed to interlock. Each tile measures 400mm x 400mm x 18mm (5<sup>3</sup>/<sub>4</sub>" x 15<sup>3</sup>/<sub>4</sub>" x <sup>3</sup>/<sub>4</sub>"). The tiles can be used on their own or together with a range of accessory items to create sloped edges for a completely finished look.

Made of PP (polypropylene).

Alternative uses for residential lawns or garden furniture and suitable for use on grass or screed to create areas for recreational activities and/or walkways.

Industrial and commercial uses to create walkways, work areas, defined sales areas in showrooms, etc.

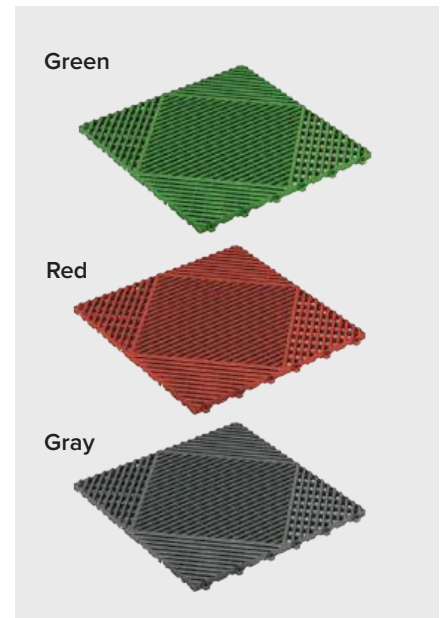
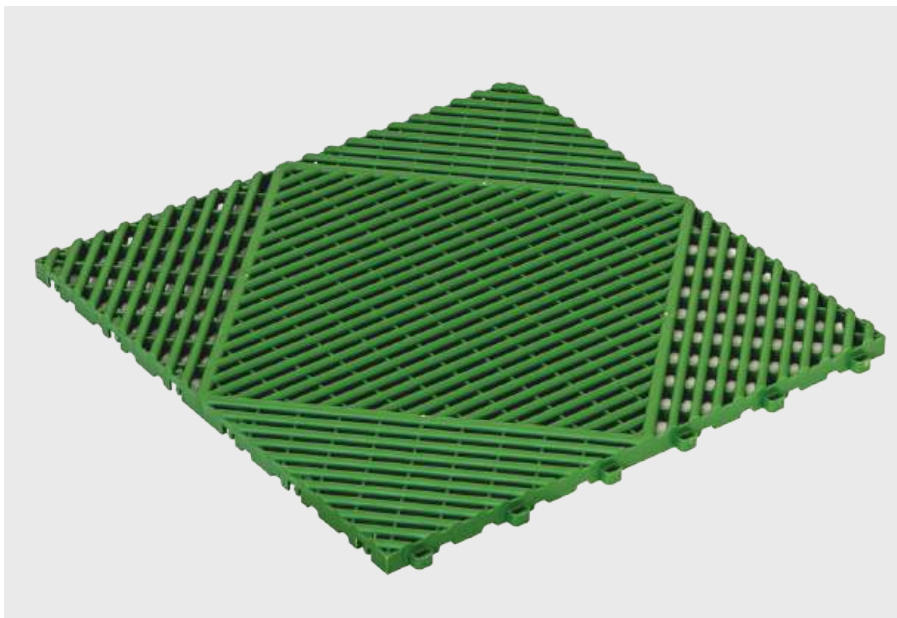

Code	Product	mm	in.	Pack size	Pallet
GAR01-0015V	Green Draining Tile	400 x 400 x 18	15 <sup>3</sup> / <sub>4</sub> x 15 <sup>3</sup> / <sub>4</sub> x <sup>3</sup> / <sub>4</sub>	6 pcs.	324 pcs.
GAR01-0015R	Red Draining Tile	400 x 400 x 18	15 <sup>3</sup> / <sub>4</sub> x 15 <sup>3</sup> / <sub>4</sub> x <sup>3</sup> / <sub>4</sub>	6 pcs.	324 pcs.
GAR01-0015GC	Grey Draining Tile	400 x 400 x 18	15 <sup>3</sup> / <sub>4</sub> x 15 <sup>3</sup> / <sub>4</sub> x <sup>3</sup> / <sub>4</sub>	6 pcs.	324 pcs.

## Accessories for draining tiles

The accessories are designed to provide a perfect edge finishing to prevent any possibility of tripping.

The side ramps and corners have a modular interlocking system.

### Types

- Ramp with “female” (ref. 2) or “male” interlocking system (ref. 3)
- Corner for with “female”(ref. 4) or “female-female” (ref. 5)

Ramps are sold in bags of 10 pieces/each.

Both ramps and corners are made of PP (polypropylene).

Ramps and corners can be easily matched together and the locking system guarantees quick positioning and use.

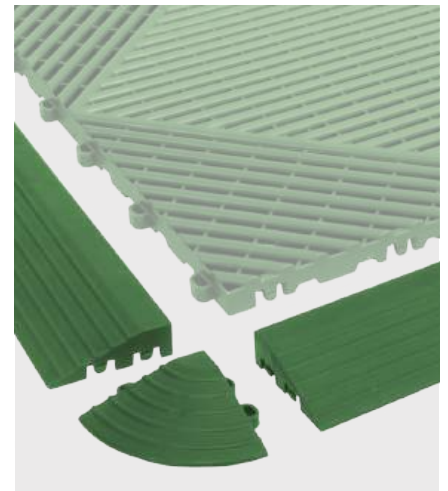

Code	Ref	Product	mm	in.	Pack size	Pallet
GAR01-0030V	1	Green Ramp - “female” hooking	400 x 60 x 18	15 <sup>3</sup> / <sub>4</sub> x 2 <sup>3</sup> / <sub>8</sub> x <sup>3</sup> / <sub>4</sub>	25 pcs.	1,575 pcs.
GAR01-0030R	1	Red Ramp - “female” hooking	400 x 60 x 18	15 <sup>3</sup> / <sub>4</sub> x 2 <sup>3</sup> / <sub>8</sub> x <sup>3</sup> / <sub>4</sub>	25 pcs.	1,575 pcs.
GAR01-0030GC	1	Gray Ramp - “female” hooking	400 x 60 x 18	15 <sup>3</sup> / <sub>4</sub> x 2 <sup>3</sup> / <sub>8</sub> x <sup>3</sup> / <sub>4</sub>	25 pcs.	1,575 pcs.
GAR01-00301V	2	Green Ramp - “male” hooking	400 x 60 x 18	15 <sup>3</sup> / <sub>4</sub> x 2 <sup>3</sup> / <sub>8</sub> x <sup>3</sup> / <sub>4</sub>	25 pcs.	1,575 pcs.
GAR01-00301R	2	Red Ramp - “male” hooking	400 x 60 x 18	15 <sup>3</sup> / <sub>4</sub> x 2 <sup>3</sup> / <sub>8</sub> x <sup>3</sup> / <sub>4</sub>	25 pcs.	1,575 pcs.
GAR01-00301GC	2	Gray Ramp - “male” hooking	400 x 60 x 18	15 <sup>3</sup> / <sub>4</sub> x 2 <sup>3</sup> / <sub>8</sub> x <sup>3</sup> / <sub>4</sub>	25 pcs.	1,575 pcs.
GAR01-0032V	3	Green Ramp - “female” hooking	60 x 60 x 18	2 <sup>3</sup> / <sub>8</sub> x 2 <sup>3</sup> / <sub>8</sub> x <sup>3</sup> / <sub>4</sub>	100 pcs.	14,400pcs.
GAR01-0032R	3	Red Ramp - “female” hooking	60 x 60 x 18	2 <sup>3</sup> / <sub>8</sub> x 2 <sup>3</sup> / <sub>8</sub> x <sup>3</sup> / <sub>4</sub>	100 pcs.	14,400pcs.
GAR01-0032GC	3	Gray Ramp - “female” hooking	60 x 60 x 18	2 <sup>3</sup> / <sub>8</sub> x 2 <sup>3</sup> / <sub>8</sub> x <sup>3</sup> / <sub>4</sub>	100 pcs.	14,400pcs.
GAR01-0033V	4	Green Ramp - “female/female” hooking	60 x 60 x 18	2 <sup>3</sup> / <sub>8</sub> x 2 <sup>3</sup> / <sub>8</sub> x <sup>3</sup> / <sub>4</sub>	100 pcs.	14,400pcs.
GAR01-0033R	4	Red Ramp - “female/female” hooking	260 x 60 x h. 18	1 <sup>1</sup> / <sub>3</sub> x 2 <sup>1</sup> / <sub>3</sub> x h. <sup>7</sup> / <sub>10</sub>	100 pcs.	14,400pcs.
GAR01-0033GC	4	Gray Ramp - “female/female” hooking	60 x 60 x h. 18	2 <sup>1</sup> / <sub>3</sub> x 2 <sup>1</sup> / <sub>3</sub> x h. <sup>7</sup> / <sub>10</sub>	100 pcs.	14,400pcs.





# DAKOTA

United Kingdom

Unit B, Wainstalls Business Park, Wainstalls, Halifax, West Yorkshire, HX2 7UR  
+44 (0)1422 872273 sales@dakota.co.uk www.dakota.co.uk